

Technology - Basic principles

Expertise, performance, innovation

ebmpapst

The engineer's choice

ebmpapst



As a leading supplier of ventilation and drive engineering technology, ebm-papst is a highly respected engineering partner in many industries. With over 15,000 different products, we can provide the right solution for almost any application. And all our fans and drives are reliable, quiet-running and energy-efficient.

Six things that make us the ideal partner:

Our systems expertise.

Naturally you will always want the best solution for every project. This can only be achieved by considering the ventilation and drive engineering aspects as a whole. And that is precisely what we do: With motor technology that sets standards, sophisticated electronics and aerodynamically optimized designs – all from a single supplier and perfectly matched. These system solutions create potential for unique synergy effects worldwide. What's more: They save you a lot of work, so you can concentrate on your main area of expertise.

The ebm-papst spirit of invention.

Alongside our wide range of products, our team of 600 specialist engineers and technicians at our four German plants in Mulfingen, Landshut, St. Georgen and Lauf is always on hand to develop customized solutions to suit your requirements. Just get in touch with us to discuss your latest project.

Our cutting-edge technology.

Our pioneering, ground-breaking development work in the field of highly efficient EC technology gives us a massive lead over other motor manufacturers. Almost all our products can be supplied with GreenTech EC technology today, offering you unrivalled advantages: Greater efficiency, maintenance-free and longer service life, noise minimization, intelligent control characteristics and unrivalled energy efficiency with savings of up to 80% as compared to conventional AC technology. Use our cutting-edge technology to your competitive advantage.

Proximity to our customers.

ebm-papst has 57 sales offices worldwide, 47 of which are subsidiaries with an extensive network of sales representatives and distributors. So there is always someone nearby to contact, who speaks your language and is familiar with your market.

Our quality standards.

It goes without saying that you can depend on the top quality of our products, because we employ an uncompromising quality management system at every stage of the process.

This is underscored, for example, by our certification according to the international standards DIN EN ISO 9001, ISO/TS 16949-2 and DIN EN ISO 14001.

Our sustainable approach.

Assuming responsibility for the environment, for our employees and for society is an integral part of our corporate philosophy. That is why we develop products with an eye to maximum environmental compatibility and employ particularly resource-preserving production methods. We promote environmental awareness among our junior staff and are actively involved in sporting, cultural and educational activities. That's what makes us one of the "better companies" – and a better partner for you.

Contents.



Foreword: Ideal partner – Contents	02 03
Fans	04 61
Axial fans	14 29
Centrifugal fans	30 47
Diagonal fans	48 55
Tangential blowers	56 61
Motors	62 71
EC motors	66 67
AC motors	68 71
Control electronics	72 85
Open-loop control of EC motors	76 83
Open-loop control of AC motors	84 85
Appendix	86 127
Factors influencing fan performance	88 91
General performance parameters	92 99
Performance measurement	100 103
Aerodynamics	104 105
Acoustics	106 109
Operating point	110 111
Efficiency figures	112 113
Electronics and EMC	114 121
Physical quantities, symbols, units	122 125
Index	126 127

Fans Designs

Like pumps and compressors, fans are a type of fluid machine. A fan consists of an impeller and a drive motor, as well as a housing for flow control. The rotating blades are designed such that they change the direction of flow of the working medium, applying pressure and kinetic energy to it in the process.

A distinction is made between various designs based on the geometrical shape of the impeller, with the designation referring to the principal flow direction in the impeller.

The main technologies employed in ebm-papst fans are:

Drive technologies

The technology determines the drive system used. The different types are:

- DC technology (direct current)
- EC technology (direct current, electronic commutation)
- AC technology (alternating current)

Further information on drive technologies can be found in the section on Motors.

Control technologies

Information on this topic can be found in the section on Control electronics.

Axial fans



HyBlade sickle-shaped blade

The key features of axial fans are their shallow installation depth, a low noise level and outstanding efficiency. With an axial fan, similar to a propeller in operation, the air is conveyed in axial direction in parallel with the rotating motor shaft.

Centrifugal fans

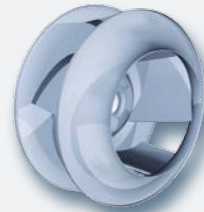

Impeller with backward-curved blades

Centrifugal fans with backward-curved blades are primarily used as intake fans. The pressure increase essentially takes place in the impeller, and so there is generally no need for a scroll housing. Centrifugal fans exhibit extremely good hydraulic efficiency and a low noise level and are well suited to higher pressures.



With or without fan housing.

Both airflow directions

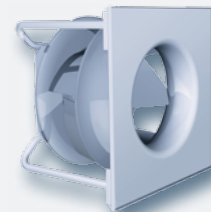

Without scroll housing

Single inlet

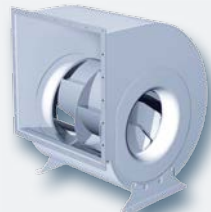

Scroll housing

Dual inlet

Diagonal fans

Tangential blowers

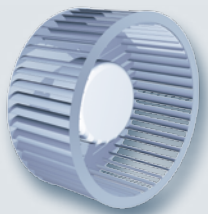

Impeller with forward-curved blades

The characteristic features of centrifugal fans with forward-curved blades are their minimal noise generation and a high power density. They are employed wherever there is a need to move large volumes of air in a confined space.



Diagonal fans - axial type

The operating point of a diagonal fan is in a higher pressure range than that of an axial fan: Diagonal fans provide more pressure with a considerably higher air flow rate.



Diagonal fans - centrifugal type

Centrifugal-type diagonal fans combine the positive features of axial and centrifugal flow machines. These advantages are put to best use in the medium pressure range: Pressure insensitivity even with increasing pressure loss – and at the same time high efficiency with a low noise level. The diagonal outflow produces a more uniform through-flow, significantly reducing the formation of harmful "hotspots" and thus extending the service life.

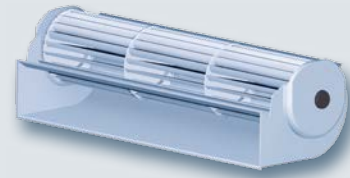

Tangential blower

Tangential blowers provide uniform, quiet air distribution over the entire blower width and are used in confined spaces. Tangential blowers are suitable for high air flow rates with low back pressures.



Scroll housing
Single inlet



Scroll housing
Dual inlet

Fans

Airflow direction

Axial fans



The air intake and outlet direction of an axial fan runs in parallel with the axis. One characteristic feature of axial fans is their large contact area. They have a shallow installation depth. Power consumption is at its lowest without back pressure (free air). The power requirement increases with rising back pressure. Axial fans need a housing to guide the air. They can be used without a housing in certain cases but this results in a 10–15% reduction in performance.

Centrifugal fans

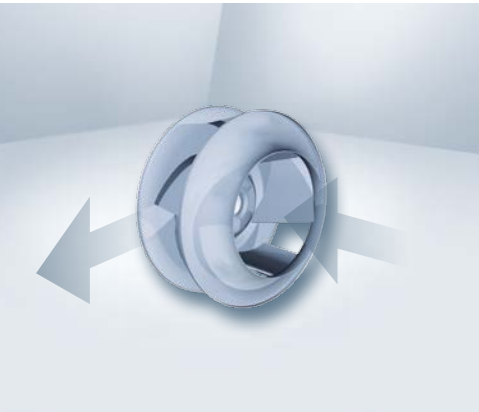

The air intake direction of a centrifugal fan runs in parallel with the fan shaft. The air flow is then diverted by 90° in the impeller, which its leaves in centrifugal direction. A distinction is basically made between two main types of centrifugal impeller: Centrifugal impellers with backward-curved blades and forward-curved blades (in running direction). Impellers with backward-curved blades can be used without a housing. They can however also be operated with a scroll housing to guide the air. By contrast, impellers with forward-curved blades always require a scroll housing for optimum flow. With regard to housings, a distinction is made between single-inlet and dual-inlet designs.

Diagonal fans



A variation on the axial fan is the so-called diagonal fan, in which the housing and fan blades are of conical shape (the diameter becomes larger towards the outlet side). This causes the air to emerge diagonally. For the same performance and size, diagonal fans have a somewhat lower air throughput than axial fans and build up a higher pressure. A distinction is again made between two types of diagonal fan: Diagonal fans of axial design and diagonal fans of centrifugal design.

Tangential blowers



Tangential blowers have drum-shaped impellers, the blades of which are arranged in parallel with the axis of rotation. The air flows through the blade drum twice in centrifugal direction - from the outside to the inside in the intake area and from the inside to the outside in the outflow area. A distinction is made between crossflow blowers with 90° and 180° air routing. Their large air volume is distributed over a wide area. The pressure increase is relatively low and the curve is stable. In addition to compact dimensions they offer a low noise level. Power consumption is at its highest without back pressure, i.e. in free air operation.

Fans Performance

Dimensionless numbers are used as a means of assessing and comparing fans. Its position in the so-called Cordier diagram illustrates how far away a fan is from the "optimum" solution. These numbers do not depend on the speed n , density ρ_1 or the static pressure p_{fs} . The following quantities are of relevance:

– Dimensionless air flow (flow coefficient)

$$\varphi = \frac{4 \cdot q_v}{\pi^3 \cdot D^3 \cdot n}$$

– Dimensionless pressure (pressure coefficient)

$$\Psi = \frac{p_{fs}}{\rho \cdot \underbrace{\pi^2 \cdot D^2 \cdot n^2}_{u^2}} = \frac{2 \cdot y_t}{(\pi \cdot D \cdot n)^2}$$

– Dimensionless shaft power (power coefficient)

$$\lambda = \frac{8 \cdot P_2}{\rho \cdot \pi^4 \cdot D^5 \cdot n^3}$$

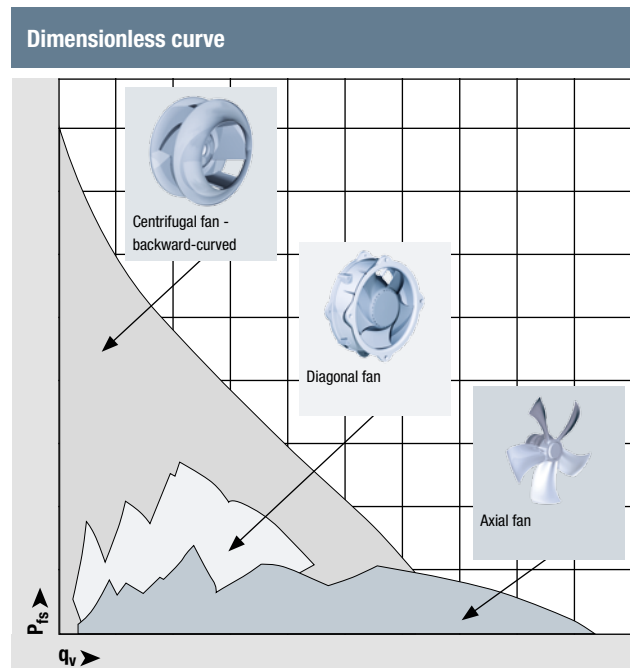

This illustration shows the typical curve maps for axial, centrifugal (backward-curved) and diagonal fans.

Optimum operating range

Axial fans supply high air flow rates with low static pressure (shallow curve) and are often also used in free air operation. An axial fan with an external rotor motor is of extremely shallow design. To ensure efficient operation, sufficient space is however required in front of and behind the fan to allow a good inward and outward flow of air.

Centrifugal fans are primarily used in applications where a higher back pressure has to be overcome. This is the case for example in air handling units or for cooling power electronics.

Diagonal fans are positioned between the two above-mentioned versions in terms of their operating characteristics. They are the best choice if axial fans would not supply sufficient pressure and centrifugal fans would yield too low an air flow rate.

Tangential blowers provide high air flow rates with low back pressures and extremely good noise characteristics. They are however not particularly efficient and are therefore only used for very low air performance levels.

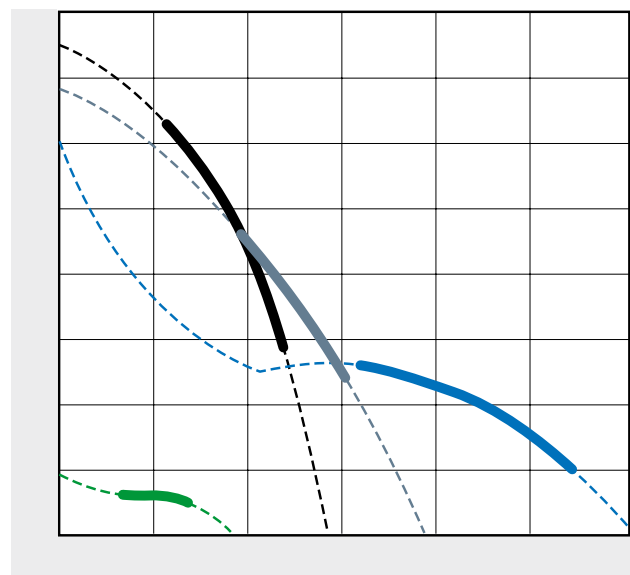

- Characteristic curve for axial fans
- Characteristic curve for centrifugal fans
- Characteristic curve for diagonal fans
- Characteristic curve for tangential blowers

Fans from ebm-papst

Axial fans



Axial fans from ebm-papst

Axial fans form a compact unit with the ebm-papst external rotor motor being directly integrated into the axial impeller. For mounting, use is generally made of fan housings in short or long nozzles. It is possible to choose between GreenTech EC technology with its good control characteristics and precise air flow control, and AC technology. A variety of connection options, some permitting individual positioning, facilitate integration: e.g. for network connection or bus-compatible interfaces. Added to this is a wide range of designs, sizes, air performance levels and protection classes, as well as VDE, UL, CSA, CE and EAC approval.

Centrifugal fans



Centrifugal fans from ebm-papst

ebm-papst centrifugal fans are supplied in the form of either components or ready-to-use units. The minimum scope of delivery includes the motor and the flow machine, in this case a centrifugal impeller. Standard centrifugal fans are suitable for indoor installation and can be adapted to other climatic conditions as required. Various mechanical alternatives are available to facilitate incorporation into customer devices. Quick and easy initial commissioning is possible when supplied as ready-to-use units.

Diagonal fans



Diagonal fans from ebm-papst

ebm-papst diagonal fans are supplied as compact units with the motor integrated directly into the fan impeller. Many different sizes, connection options and designs permit usage in all sorts of applications. GreenTech EC technology provides precise control of the air flow, with optional tach output, linear or PWM input, bus-compatible interfaces and various sensors. Reliable AC technology is also available for special areas of application. Special seals preventing the ingress of dust and water and numerous approvals, such as VDE, UL, CSA, CE and EAC, make the fans suitable for use around the world.

Tangential blowers



Tangential blowers from ebm-papst

ebm-papst tangential blowers are equipped with an asymmetrical shaded-pole motor, a capacitor motor or a GreenTech EC motor with integrated commutation electronics (incl. tach output and PWM or analog input). Special features facilitate incorporation into particular customer applications. These include moisture-proof versions for refrigeration systems and GreenTech EC motors providing a higher speed than shaded-pole or capacitor motors, to overcome higher back pressures for example. EC technology automatically sets the required operating points via corresponding sensors. Solutions with cascade drum arrangement are available for special applications (floor convectors), i.e. one motor with up to 4 drums in series.

Fan selection

Selection criteria

The following parameters are of crucial importance when selecting a fan for a specific application:

Operating conditions:

- Nominal voltage
- Line frequency

Fan performance requirements

- Air flow
- Back pressure (compression)
- Noise requirements
- Efficiency requirements

Influence of the application/surroundings:

- Ambient/usage conditions
- Application (area)
- Degree of protection as per EN 60529
- Flow medium temperature
- Ambient temperature
- Installation position
- Flow paths and distances
- Life expectancy
- Mode of operation
- Winding protection TOP / TL
- Approvals: VDE, UL, CSA, CCC, EAC
- Available installation space

Components



ebm-papst can provide ventilation technology solutions to suit virtually every conceivable task. For air conditioning, ventilation, refrigeration, heating and industrial applications, users can generally find just what they need in our comprehensive standard product ranges. Alternatively we can supply customized design-in solutions developed together with users and then adapted to the application concerned. An ebm-papst fan always consists of at least a flow machine and an electric motor. The flow machine may take the form of a so-called axial, centrifugal, diagonal or tangential impeller.

Possible motor versions are asynchronous motors (AC motors), line-fed direct current motors (EC motors) and direct current motors (DC motors). With just a few exceptions, use is always made of external rotor motors. With this design, the stator forms the center of the motor and the rotor rotates around this stator. An external rotor motor is basically the opposite of the standard design, in which the rotor is located inside the motor and surrounded by the stator. External rotor motors are ideal drive motors for fans, as the flow machine (impeller) can be mounted directly on the rotor.

Impeller

The impeller is the crucial component with regard to accelerating the air and generating work in the form of pressure. Only a few design principles have proven successful when it comes to moving air. ebm-papst can offer axial, centrifugal, diagonal and tangential-type impellers. The designations relate to the principal direction of flow through the impeller. With axial fans, the inflow is in axial direction and the air also leaves the fan in axial direction. A distinction is made between two types of centrifugal impeller: Impellers with forward-curved blades and impellers with backward-curved blades. As with axial impellers, both of these feature axial inflow, but the air is blown out in centrifugal direction. Centrifugal impellers with backward-curved blades can be provided with a scroll housing – centrifugal impellers with forward-curved blades have to have a scroll housing to function efficiently. With diagonal impellers, the inflow is axial.

Motor

Most ebm-papst motors are of the so-called external rotor motor type. The impellers described (with the exception of tangential drums) are mounted directly on the rotor of the motor. This makes the impeller-motor unit extremely short and compact. It also means that the rotating masses (impeller and rotor) can be jointly balanced in one clamping operation. Particularly good balancing of the rotating unit is thus achieved. AC external rotor motors are operated directly on line voltage. Windings can be designed for all conceivable voltages and frequencies. Both single-phase AC motors (1~) and three-phase motors (3~) are constructed on this principle. Pre-fabricated cables or a terminal box are provided for supply connection. As the name implies, the line-fed DC motors with electronic commutation are also connected to and operated with a 1-phase or 3-phase AC supply. The mode of operation of the attached commutation electronics is comparable to that of a variable frequency drive.

Electronics

Commutation electronics are required to operate an EC motor. The electronics employ sensors to detect the position of the rotor with respect to the coils of the stator winding. Depending on the position the corresponding coils are energized, causing the rotor to rotate. As well as correctly energizing the coils, the electronics can also process additional control signals and send status information.

The principal outflow direction is at an angle of 20° to 70° to the axis of rotation. Below 20° and above 70° these fans are classed as being axial or centrifugal fans. The inflow with tangential impellers (also known as tangential drums) is completely different to that of the above-mentioned impellers. This also applies to the outflow. The air enters the drum at right angles to the axis of rotation and leaves it again at right angles to the axis of rotation. The air thus passes through the impeller blades twice.

Due to its synchronous operation (no slip loss as with an asynchronous motor) and the permanent magnets fitted in the rotor, an EC motor will however always be more efficient than an AC motor. A further positive aspect is that ebm-papst EC external rotor motors do not rely on the problematic supply of rare earth magnets. The operating principle of the external rotor motor makes it possible to produce a sufficiently dense magnetic flux using permanent magnets made of inexpensive ferrite. Low-voltage DC motors basically function in exactly the same way as EC motors, except that there is no need for rectification at the inlet and commutation takes place at a far lower voltage level (e.g. 12, 24, 48 VDC).

Type code

Type code for fans from ebm-papst Mulfingen

What information is contained in the type code of ebm-papst products from Mulfingen?

The first six positions are of particular importance. These indicate the type, motor, and size of the fan. The last six positions are codes for mechanical and electrical designs and variants. Their meaning is only to be found in the data processing system.

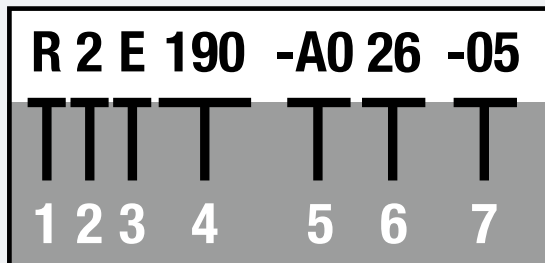

Meaning:

- Centrifugal fan
- 2-pole
- Single-phase AC
- Impeller diameter 190 mm

The designations of fans from ebm-papst Mulfingen are based on this type code for ease of identification and ordering:

1) Type

- A-Axial fan
- S-Axial fan with guard grill
- W-Axial fan with fan housing
- V-Axial combination
- R-Centrifugal fan, single inlet without housing
- G-Centrifugal blower, single inlet (with scroll housing)
- B-Centrifugal fan, dual inlet without housing
- D-Centrifugal blower, dual inlet (with scroll housing)
- K-Centrifugal combination
- M-Motor
- P-Pumps

2) Number of poles (AC) or number of phases (EC)

2, 4, 6, 8 and 12-pole (Z = 12) or single and three-phase

3) Type of motor

- D-Three-phase motor
- E-Single-phase motor with motor run capacitor
- G-EC motor
- S-Shaded-pole motor
- Q-Square shaded-pole motor

4) Diameter in mm

- Impeller diameter (fans)
- Air gap diameter (motors)

5) Code for mechanical design (fans) or code for overall length (motors)

6) Code for electrical design

7) Code for mechanical variants

The quick way to find the best product for your application: The ebm-papst FanScout

Not powerful enough means inadequate cooling – too powerful on the other hand means unnecessary energy consumption. Reliable fan selection software is needed to determine just the right solution to suit specific requirements.

With its outstanding user-friendliness and real measured values, the ebm-papst FanScout has already more than proven its worth. The program enables users to quickly select the best fan for the application concerned, to display and alter the operating characteristics and to record the technical data. Factors such as air performance, operating time and installation space can be taken into account in this process. The differences between the data calculated in this way and actual measurements **have been checked by TÜV SÜD, who judged the calculation accuracy to be of the highest class.**



Better decisions thanks to more accurate assessment of the life cycle costs: The costs of operation, acquisition, installation and service can be calculated for a defined period of time. **A practical advantage: Easy incorporation of the software into your device configuration program via DLL interface.**

Now with innovative FanGrid selection function.

For both centrifugal and axial fans, making the right choice is what really matters! That's why the new version now also features a unique selection function for FanGrids. The FanScout makes it possible to work out the most economical fan combination from the ebm-papst range. The input parameters are: Installation space, air performance, operating time, investment and service costs. You can then be sure of finding the most efficient FanGrid for every application.

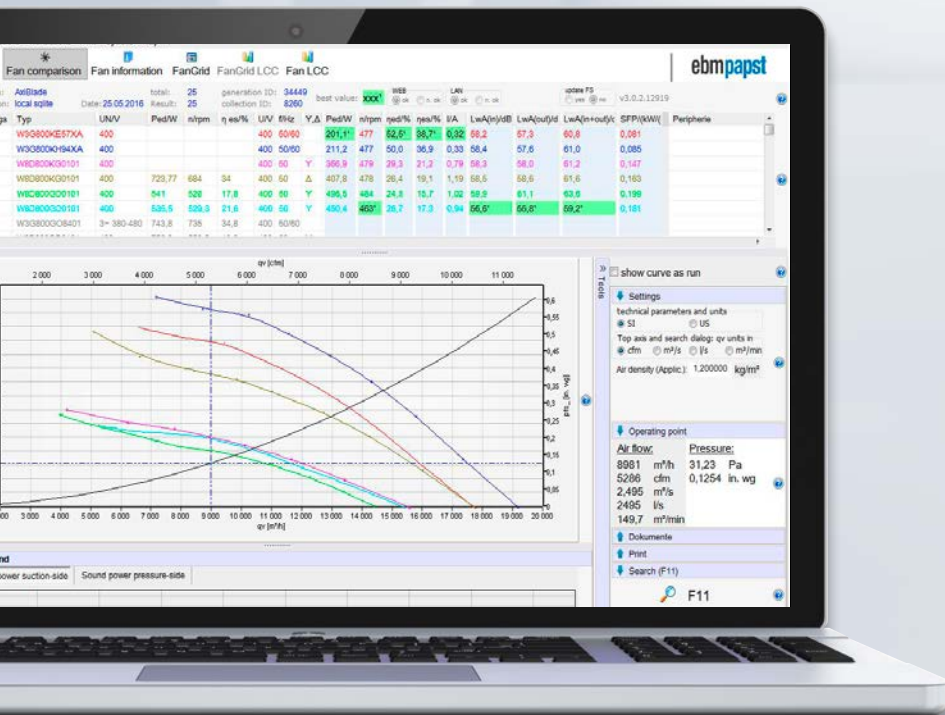



Axial fans



Axial fans

The truly space-saving axial fans from ebm-papst are used to exchange hot and cold air in all sorts of devices and systems. Their outstanding features include a shallow installation depth, a low noise level and excellent efficiency, making them particularly suitable for conveying air through heat exchangers. In combination with GreenTech EC technology they also provide an intelligent means of saving energy in a whole range of different applications.

The facts at a glance:

- Compact dimensions
- Choice of GreenTech EC or AC technology
- Many different designs, sizes and air performance levels
- Optimum efficiency and minimal noise generation thanks to aerodynamically optimized fan blades
- Highly efficient, energy-saving versions with GreenTech EC technology and standardized integration of control functions and sensor signals
- Wide range of guard grills, basket guard grills and fan housings as accessories
- All axial fans are dynamically balanced on two planes in accordance with DIN ISO 1940
- Numerous approvals including VDE, UL, CSA, CCC and EAC
- Areas of application: Ventilation, refrigeration, air conditioning, automotive industry, wind power plants and the machinery/equipment industry

Axial fans Performance ranges

Optimum usage range

To the right of the dip (right section of the air performance curves):

- Maximum efficiency
- Minimum noise

To the left of the dip (left section of the air performance curves):

- Stalling
- Falling efficiency
- Abrupt increase in noise

The optimum usage range of the fan is highlighted in green in the adjacent illustration.

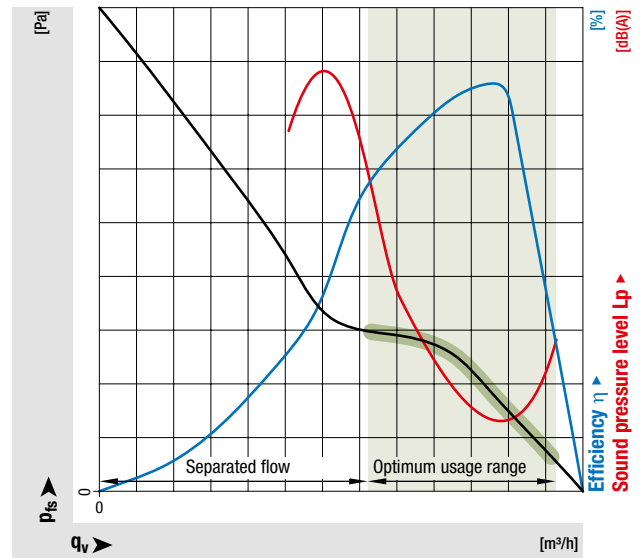

- Fan curve
- System or device curve
- Efficiency curve
- Operating point
- Noise curve
- Usage range

Selection of fans

The product catalogs contain all the relevant information on

– Product designation

The header defines the technology (AC or EC), the type (centrifugal, axial, ...), the series (e.g. S series), the impeller diameter and other features of the product.

– Product description

Depending on the product, the following items of information are presented here:
 Material, number of blades, airflow direction, direction of rotation, degree of protection, insulation class, installation position, condensation drainage holes, mode of operation, bearings, technical features, EMC, touch current, motor protection, electrical hookup, cable/terminal box design, protection class, capacitor, conformity with standards, approvals and options.

– Nominal data

AC products (up to motor size 074) and EC products (with DC supply):
 Free air/with minimum back pressure AC products (as of motor size 094) and EC products (with AC supply):
 At the operating point with maximum load

– Order designation/type

An explanation of the order designation and type is given under Type code.

– Product drawing

– Operating points

The operating points with information on speed, power consumption, current draw, sound power level or sound pressure level and overall efficiency of the impeller are listed in the adjacent Operating point table.

– Curves

The air performance curves for the product are shown in the graph.

– Accessories

The appropriate accessories (e.g. inlet rings, guard grill, fan housings) and further information (e.g. the connection diagram) can be found on the page numbers given.



EC axial fans – HyBlade®
Ø 500

- **Material:** Guard grille: Steel, coated with black plastic (RAL 9005)
Fan housing: Sheet steel, galvanized and coated with black plastic (RAL 9005)
Blades, press-fitted sheet steel blank, over-molded with PP plastic
Rotor: Painted black
Electronics housing: Die-cast aluminum, painted black
- **Number of blades:** 5
- **Direction of rotation:** Counterclockwise viewed toward rotor
- **Degree of protection:** IP55
- **Insulation class:** "F"
- **Installation position:** Shaft horizontal or rotor on bottom, rotor on top on request
- **Condensation drainage holes:** Rotor side
- **Mode:** Continuous operation (S1)
- **Mounting:** Maintenance-free ball bearings

Nominal data		Curve	Nominal voltage range	Frequency	Speed ⁽¹⁾	Max. input power ⁽¹⁾	Max. input current ⁽¹⁾	Max. back pressure	Perm. ambient temp. ⁽²⁾	Techn. features and connection diagram	
Type	Motor		VAC	Hz	rpm	W	A	Pa	°C		
*3G 500	M3G 084-DF	⊙1	1–200	277	50/60	970	250	1,10	80	-25...+60	P. 132 / P7
*3G 500	M3G 084-GF	⊙1	1–200	277	50/60	1260	500	2,20	120	-25...+60	P. 132 / P7
*3G 500	M3G 084-GF	⊙2	3–380	480	50/60	1370	630	1,00	150	-25...+60	P. 133 / P8
*3G 500	M3G 112-EA	⊙1	1–200	277	50/60	1440	740	3,25	180	-25...+60	P. 132 / P7
*3G 500	M3G 112-GA	⊙2	3–380	480	50/60	1770	1300	2,10	240	-25...+60	P. 133 / P8

(1) Nominal data at operating point with maximum load and 230 or 400 VAC.
 (2) Occasional start-up between -40°C and +25°C is permissible. Continuous operation below +25°C only possible with special low temperature bearings (on request).

Curves:

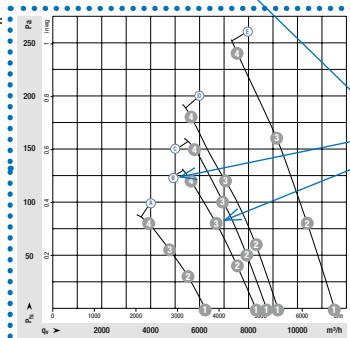

⊙	n rpm	P _{tot} W	I A	L _{WA} dB(A)
⊙1	970	177	0,82	68
⊙2	970	207	0,94	64
⊙3	970	228	1,03	62
⊙4	970	250	1,10	63
⊙5	1260	374	1,65	71
⊙6	1260	425	1,87	69
⊙7	1260	467	2,05	68
⊙8	1260	500	2,20	69
⊙9	1370	471	0,77	73
⊙10	1370	537	0,86	71
⊙11	1370	591	0,94	70
⊙12	1370	630	1,00	72
⊙13	1440	533	2,37	77
⊙14	1440	614	2,72	74
⊙15	1440	683	3,00	72
⊙16	1440	740	3,25	74
⊙17	1770	987	1,58	80
⊙18	1770	1094	1,75	78
⊙19	1770	1213	1,93	76
⊙20	1770	1300	2,10	78

Air performance measured according to ISO 5801, installation category A, in stem-pipe full nozzle without contact protection.
 Inlet-side sound level L_{WA} according to ISO 12447, L_{WA} measured at 1 m distance from fan axis. The values given are only applicable under the specified measuring conditions and may differ depending on the installation conditions. In the event of deviation from the standard configuration, the parameters must be checked in installed condition. See Page 136 ff for detailed information.

- **Technical features:** See connection diagram P. 132 ff.
- **EMC:** Immunity to interference according to EN 61000-6-2 (industrial environment)
Circuit feedback according to EN 61000-3-2
Interference emission according to EN 61000-6-4 (industrial environment), according to household appliance standard on request
- **Touch current:** $\leq 3.5\text{ mA}$ according to IEC 60990 (measuring circuit Fig. 4)
- **Electrical connection:** Via terminal box
- **Protection class:** I (with customer connection of protective earth)
- **Conformity with standards:**
 - ⊙ EN 61800-5-1, EN 60335-1, CE
 - ⊙ EN 61800-5-1, CE
 - ⊙ EN 61800-5-1, EN 60335-1 in preparation, CE
- **Approvals:**
 - ⊙ EAC, UL; ⊙ EAC, UL on request
 - ⊙ UL, CSA; ⊙ UL, CSA planned

Airflow direction	without attachments		with square full nozzle		with guard grille for short nozzle	
	kg	kg	kg	kg	kg	kg
↖	A3G 500-BK07 -G1	4,80	W3G 500-GK07 -G1	11,30	S3G 500-AK07 -G1	7,40
↖	A3G 500-BM06 -H1	5,70	W3G 500-GM06 -H1	12,30	S3G 500-AM06 -H1	8,30
↖	A3G 500-BM03 -M1	6,00	W3G 500-GM03 -M1	13,30	S3G 500-AM03 -M1	9,50
↖	A3G 500-BA74 -Z1	7,40	W3G 500-GA74 -Z1	14,40	S3G 500-AA74 -Z1	10,70
↖	A3G 500-BD59 -O1	8,90	W3G 500-GD59 -O1	15,90	S3G 500-AD59 -O1	12,20

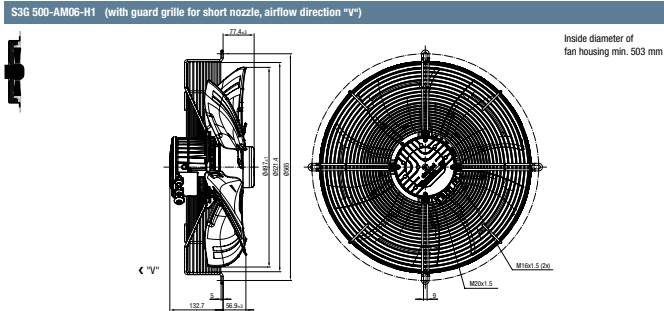

Axial fans Impellers

HyBlade

Unique hybrid structure, combination of aluminum base material and glass-fiber reinforced plastic covering, aerodynamically optimized shape, all versions available with diameters from 200 mm to 990 mm.

The outstanding features are a sophisticated aerodynamic design and low weight. Since its market launch (2007), the product range has been successfully used in all sorts of applications from deep freezing at -40°C to hot and humid conditions as in evaporative condensers and even desert climates.

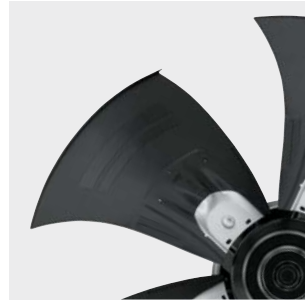

HyBlade

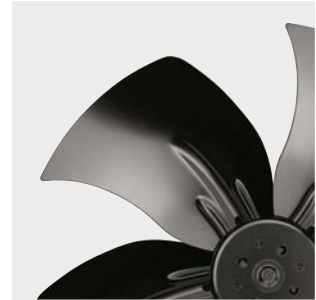

S series

AxiBlade

The AxiBlade range combines the innovative, successful materials of the HyBlade product range with the latest aerodynamic developments (e.g. blade design, wingtip, ...), with certain versions also featuring innovative peripheral components such as guide vanes, diffuser and Flowgrid. The AxiBlade product range gets more out of the standard market footprint than any other axial fan.

S series

Sickle-shaped metal blades (sheet steel or die-cast aluminum). Extremely well suited to all applications where plastic is not an option.

Airflow directions

The airflow direction is always given as follows.

The airflow direction is determined when viewed toward the rotor end face. Memory aid:

If, when looking at the rotor housing of the axial fan, the air blows towards you, this direction of air flow is given the designation "A" (otherwise "V").

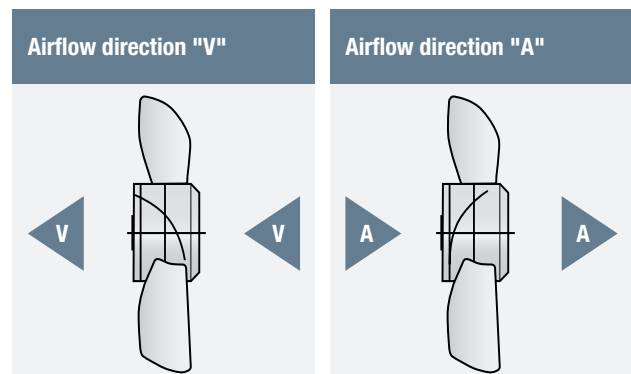

Axial fans Versions

Product ranges

- **A product range – Axial fan:** Impeller with motor.
Mounting on motor flange/stator bushing
- **S product range – Axial fan with guard grill:** Impeller with motor and guard grill. Mounting on guard grill (vertical or horizontal mounting lugs).
- **W product range – Axial fan with fan housing:** Impeller with motor, guard grill and fan housing. Mounting on fan housing



A product range



S product range

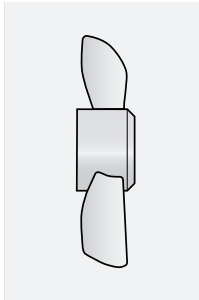

A product range

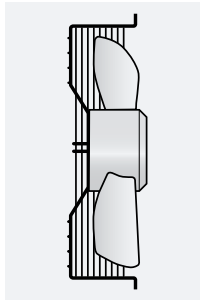

S product range

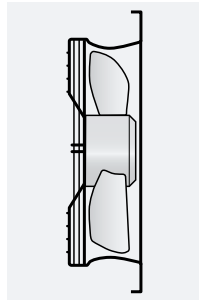

W product range



W product range



W product range with guard grill

Fan housings

- **Full nozzle:** From an aerodynamic point of view, a full nozzle is the optimum solution. Whenever possible it should be given preference over other nozzle geometries.
- **Short nozzle:** Short nozzles are used if the nozzle forms part of the housing of the customer device.
- **Double flange:** Nozzles with a double flange permit the mounting of inlet rings or integration into a duct system.



Full nozzle



Double flange

Axial fans

Fan housing and nozzle

Effects of installation in fan housing or opening

Installation in an optimally designed fan housing can greatly increase the air performance and efficiency of an axial fan.

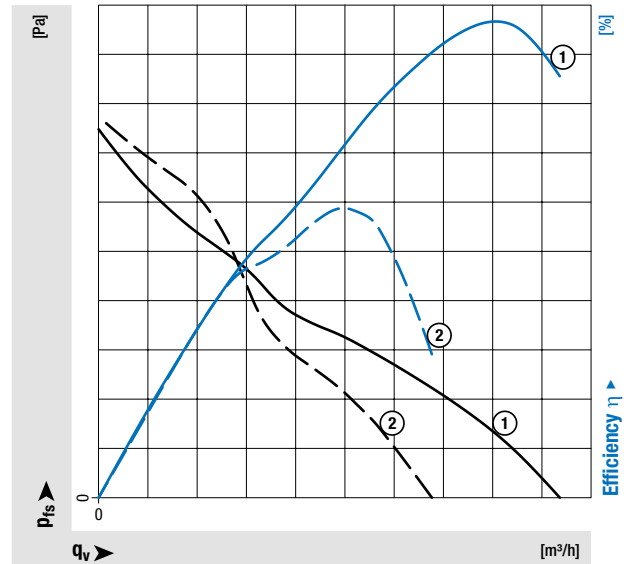
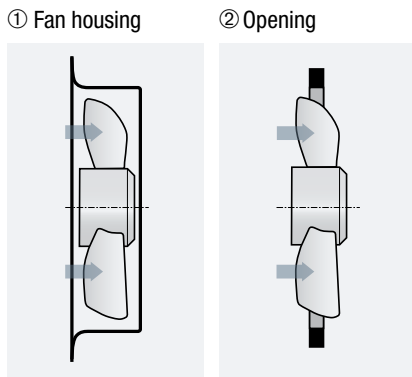

— Fan curve
— Efficiency

Effects of axial position in fan housing

The air performance and efficiency of an axial fan are also influenced by its axial position in the fan housing.

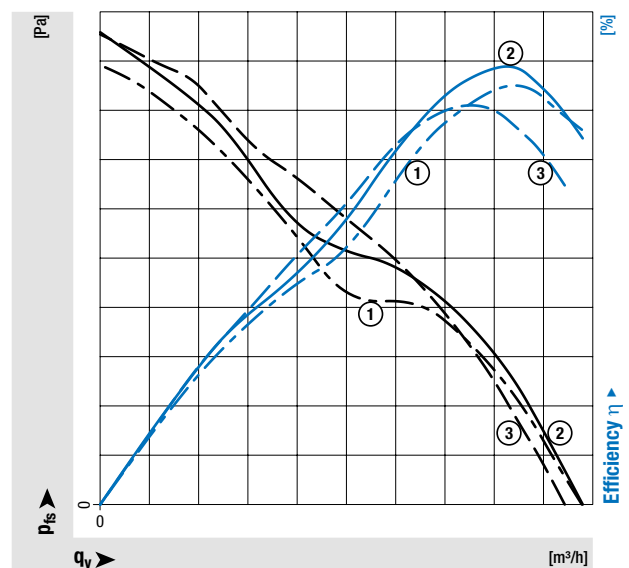
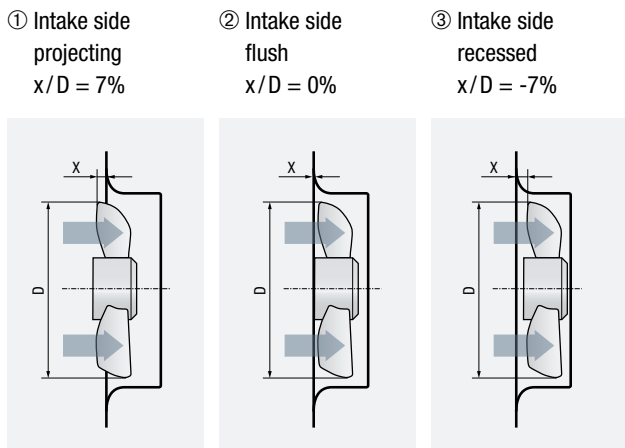

— Fan curve
— Efficiency

Axial fans

Fan housing and nozzle

Effects of fan housing geometry with axial fans

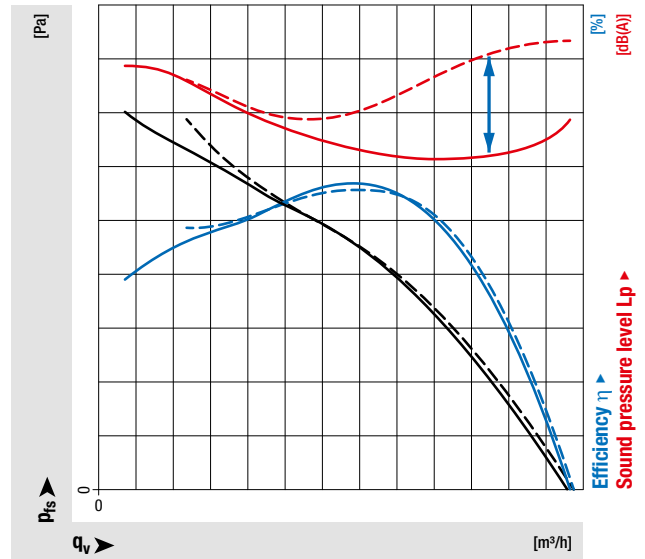
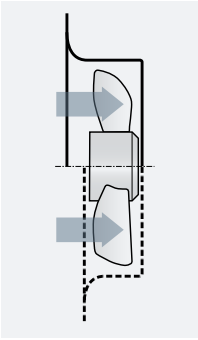

Effects of width of air gap between fan housing and blade with axial fans

In addition to the shape of the fan housing, the centrifugal air gap between the fan blades and the fan housing also has a significant influence on the technical characteristic values.

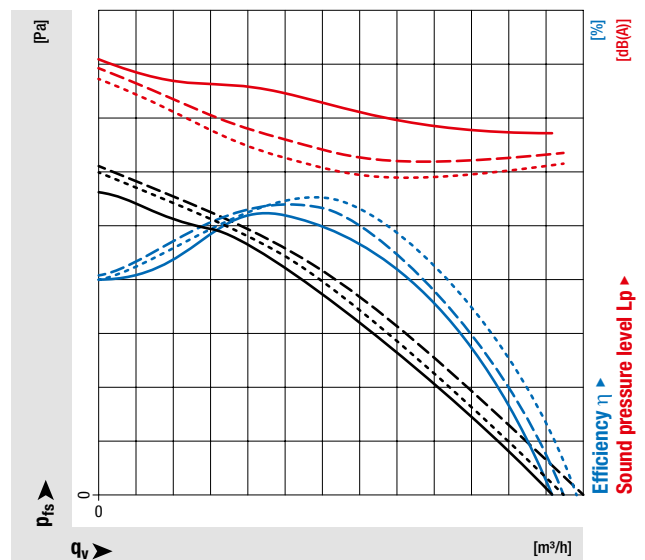
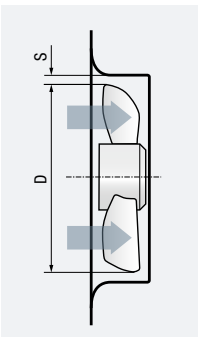

- $s / D = 0.70\%$
- - $s / D = 0.44\%$
- ... $s / D = 0.19\%$

Axial fans Guard grill

Effects of guard grill with axial fans

Fitting a guard grill reduces the air performance of an axial fan.

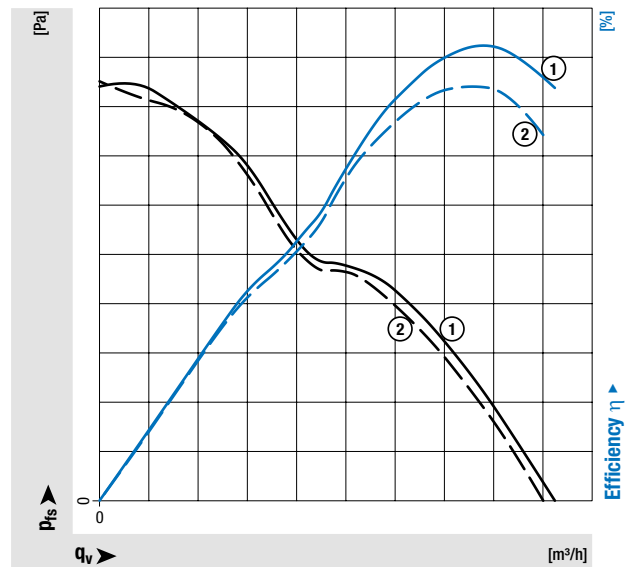

① without guard grill

② with guard grill

The pressure loss in Pa can be roughly calculated using the following equation:

$$\zeta = \frac{\frac{s}{t}}{(1 - \frac{s}{t})^2} \cdot 0.8$$

$$\Delta p_v = \zeta \cdot \frac{\rho}{2} \cdot \left(\frac{q_v}{\frac{\pi}{4} \cdot D^2} \right)^2$$

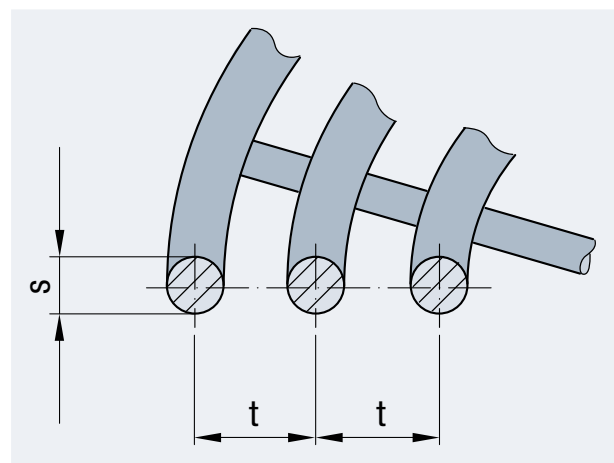

Axial fans Guard grill

Effects of guard grill with axial fans

Fitting a guard grill increases the noise level of an axial fan. The catalogs list intake-side sound power values with full nozzle or in a fan housing without guard grill.

The use of a guard grill alters the noise level on account of the flow noise.

The total sound power may increase by up to +6 dB(A) over the catalog values.

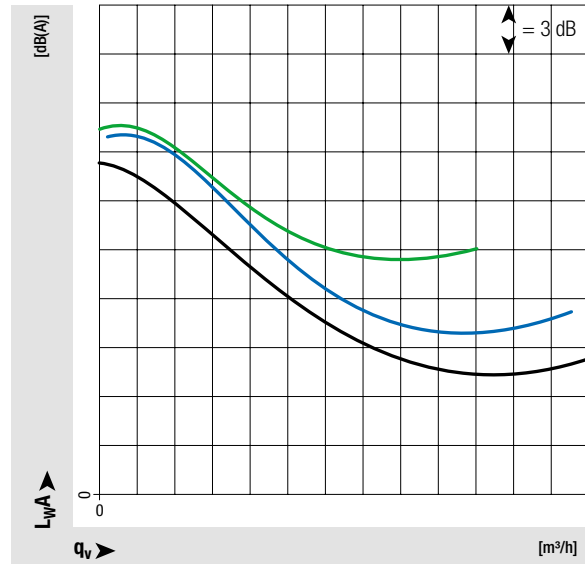

- Catalog values
- Fan with guard grill (laboratory)
- Fan with guard grill (application)

The purpose of guard grills is to prevent contact with rotating parts and the ingress of foreign matter into the fan. Guard grills do however create additional aerodynamic resistance. For this reason, the design process does not just ensure conformity with safety clearances in accordance with DIN EN ISO 13857, it also takes aerodynamic influences into account to keep the negative effects to a minimum. We nevertheless only recommend the use of guard grills in cases where it is not possible to fit other types of guard.

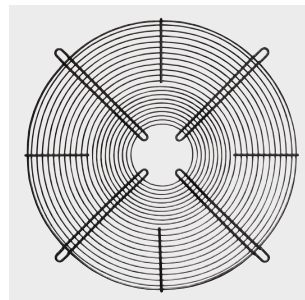

Guard grill



Guard grill with fan housing

Effects of intake obstructions

Effects of intake obstructions

Intake and outlet side obstructions reduce the air performance of axial fans.

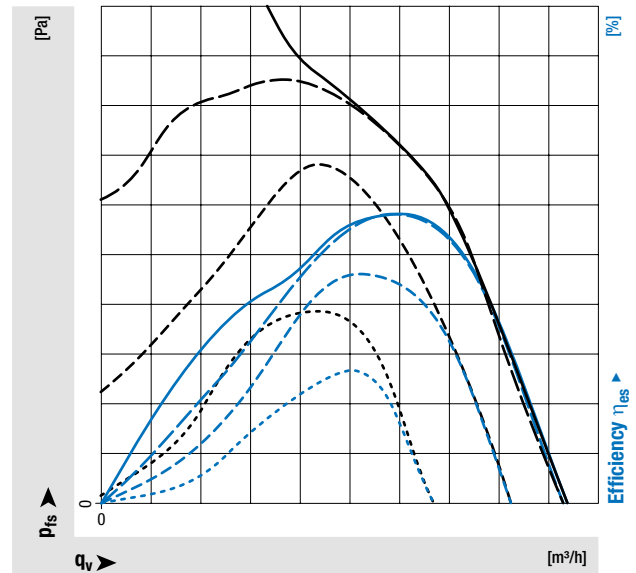
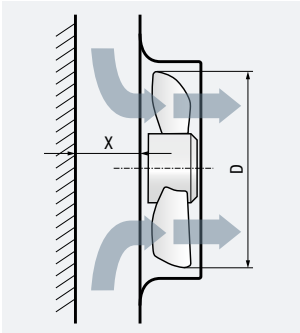

— $x/D = \infty$ - - - $x/D = 20\%$
 - - - $x/D = 40\%$ ··· $x/D = 15\%$

Effects of air-inlet guard

Additional noise occurs if the inflow of air into the fan is obstructed, as is the case with asymmetric intake for example. The turbulence directly impacts the rotating impeller blades, giving rise to what is known as propeller noise or blade passing frequency.

The FlowGrid – the air-inlet guard on the intake side – lessens the effect of inflow obstruction and so reduces the turbulence that causes noise: This reduces the sound pressure over the entire frequency range and in particular the disturbance caused by the blade passing frequency in the low frequency range.

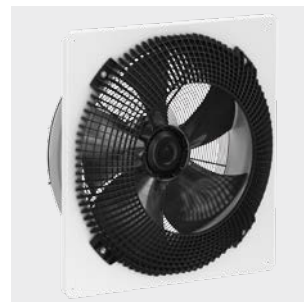

FlowGrid for axial fans

Effects of outlet obstructions

Effects of outlet obstructions

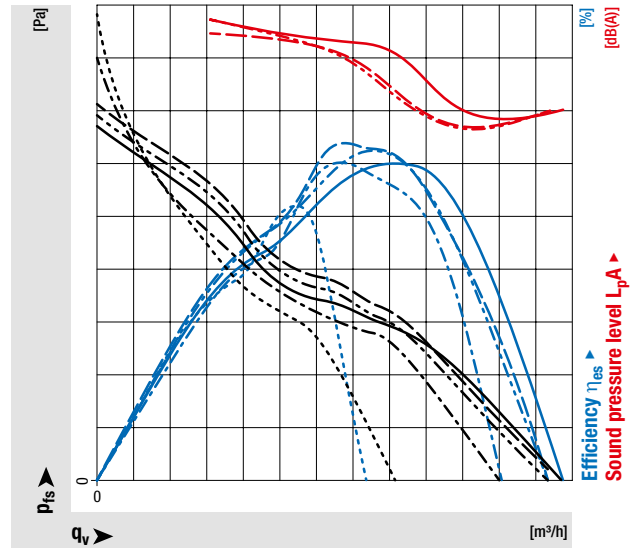
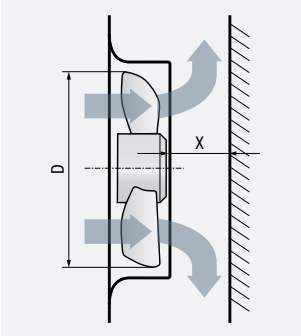

- $x / D = \infty$
- · - $x / D = 75\%$
- - $x / D = 50\%$
- · · $x / D = 25\%$
- · · $x / D = 10\%$

Guide vanes can double the fan air throw for a comparable air flow.

- More even distribution of cold air in cold stores
- Simple retrofitting of guide vanes
- Guide vanes are easily detached for cleaning



Guide vanes
(AxiCool)



Guide vanes

Axial fans Diffuser

A diffuser significantly improves efficiency and operating noise levels. As it has the effect of increasing pressure, it also minimizes outlet losses and permits better adaptation of the fan to commercially available heat exchangers.



AxiTop for axial fans

Effects of a diffuser on axial fan curves

Comparison of curves:

W3G 800-HU23-71 (with diffuser) vs.

W3G 800-GU25-01 (without diffuser)

Comparison of curves (air performance 50 Hz)

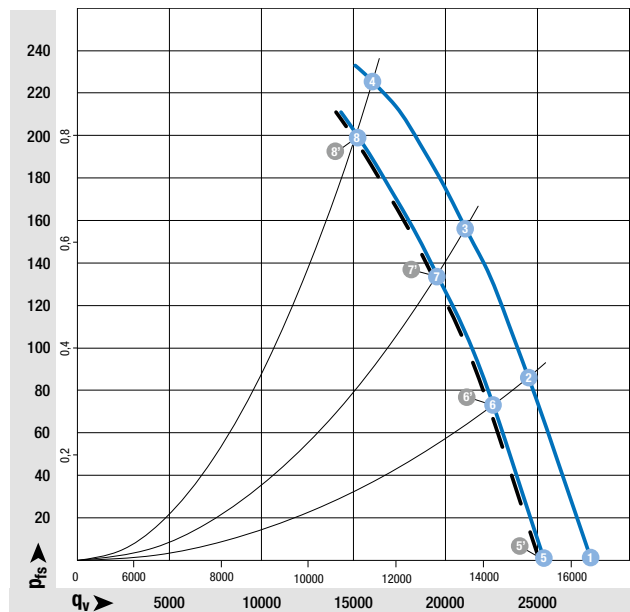

— With diffuser, with protection against contact

— Without diffuser, protection against contact

Measured values

① - ⑧ With diffuser, with protection against contact

①' - ⑧' Without diffuser, with protection against contact

	n in rpm	P _e in W	I in A	L _w A in dB(A)
①	1020	1461	2.33	81
②	1020	1817	2.85	80
③	1020	2056	3.21	81
④	1020	2325	3.50	84
⑤	925	1091	1.74	79
⑥	940	1432	2.23	78
⑦	945	1634	2.55	79
⑧	960	1953	2.94	83
①'	1020	1667	2.48	87
②'	1020	1897	2.82	85
③'	1020	2090	3.11	85
④'	1020	2368	3.52	88

Axial fans Diffuser

Reduced energy consumption and noise generation

For the same operating point, energy savings of up to 27% and a 7.2 dB(A) reduction in noise generation are possible, depending on the application. (Measurement based on size 800 mm).

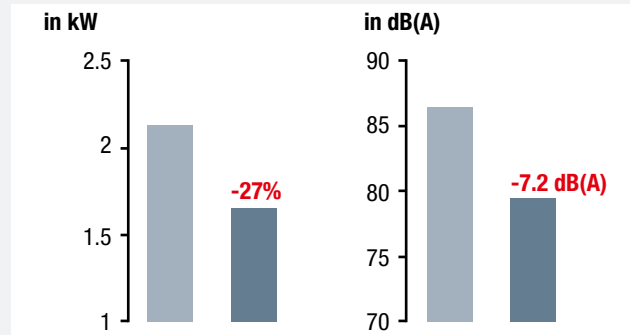

Increased air flow

When operating at maximum speed, the output can be increased by up to 9% and noise generation reduced by as much as 4.9 dB(A), depending on the application. (Measurement based on size 800 mm).

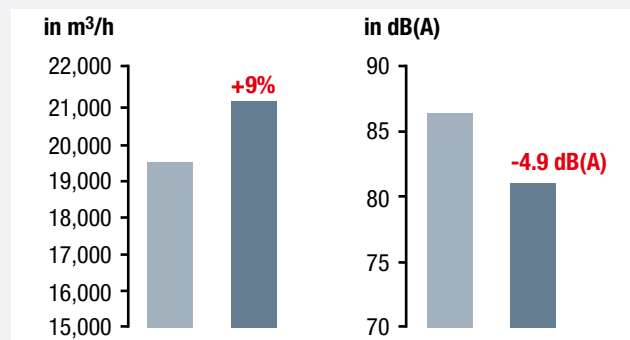

Flow losses are based on dissipation, which means that the kinetic energy of the flow is converted into heat that cannot be put to any further technical use. With the AxiTop diffuser, a great deal of the dynamic kinetic energy can be converted into static pressure by slowing down the air flow. This re-conversion boosts the pressure increase of the impeller.

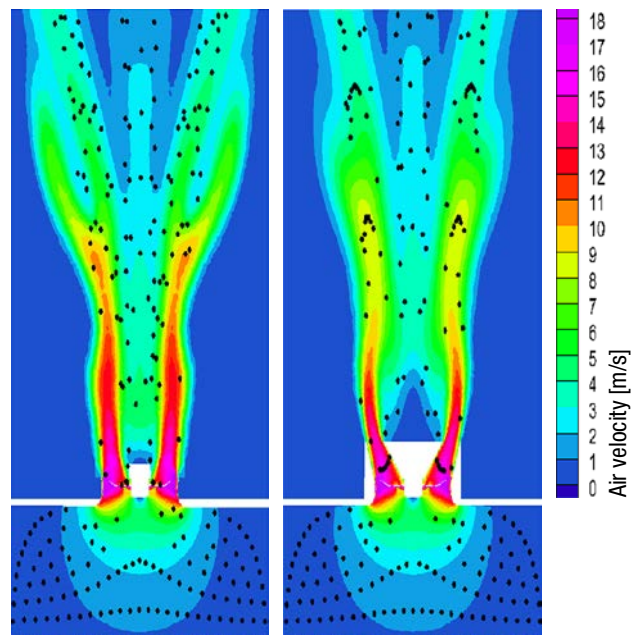

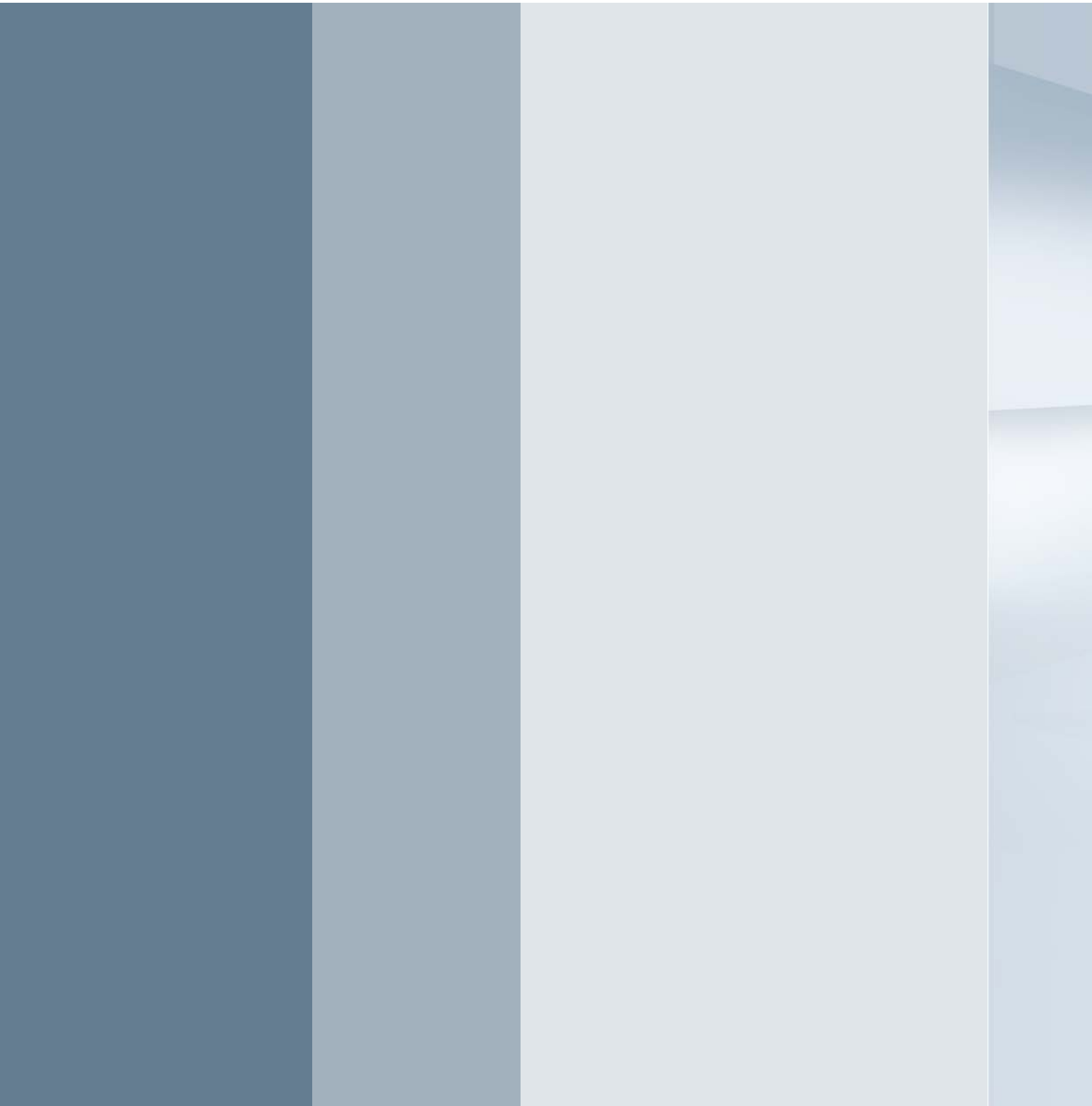

Centrifugal fans



Centrifugal fans

Centrifugal fans from ebm-papst are available with forward and backward-curved blades. The quiet-running centrifugal fans with forward-curved blades are supplied as motor-impeller combinations or with a scroll housing. The centrifugal fans with backward-curved blades have a free-running impeller and do not require a scroll housing. In the case of centrifugal fans with external rotor motors, the motor is positioned in the impeller, ensuring not just optimum cooling of the motor but also a particularly compact design. The entire range is available with both AC motor technology and GreenTech EC technology.

The facts at a glance:

- "RadiCal" AC and EC low-pressure fans
- "RadiPac" EC medium pressure fans
- "RadiFit" EC centrifugal fans with backward-curved blades and scroll housing
- EC centrifugal fans with backward-curved blades
- AC and EC centrifugal fans with forward-curved blades and scroll housing
- Compact design thanks to external rotor motor technology
- Comprehensive product ranges of fans with EC technology for all applications
- 100% speed control with analog or serial interface
- High efficiency through the use of GreenTech EC technology
- Quiet operation thanks to optimized flow control and sophisticated EC motor commutation
- Start-up made easy by perfectly matched components: Controller/motor/fan
- Wide range of accessories

Centrifugal fans

Performance ranges

Operating ranges

Optimum usage range

Optimum functioning of centrifugal fans with backward-curved blades is obtained when the operating point is close to the point of maximum efficiency. If consideration is also to be given to the economical aspect, it is best to ensure that the operating point of the fan selected is at or just to the right of the optimum point.

Centrifugal fans with forward-curved blades have different operating characteristics. Here again it is important for the operating point to be close to or slightly to the right of the optimum point – but it should be remembered that the power required by centrifugal blowers increases significantly with decreasing back pressure. This can lead to overloading of the motor.

The "ebm-papst FanScout" selection software (see Page 13) presents the important factors, namely maximum efficiency and minimum noise, so you can always make the right choice.

Forward-curved centrifugal fans

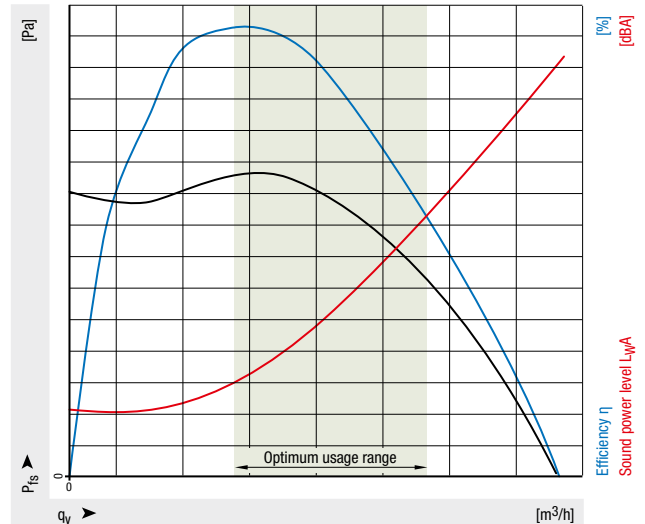

- Fan curve
- Efficiency curve
- Noise curve
- System or device curve
- Operating point
- Usage range

Backward-curved centrifugal fans

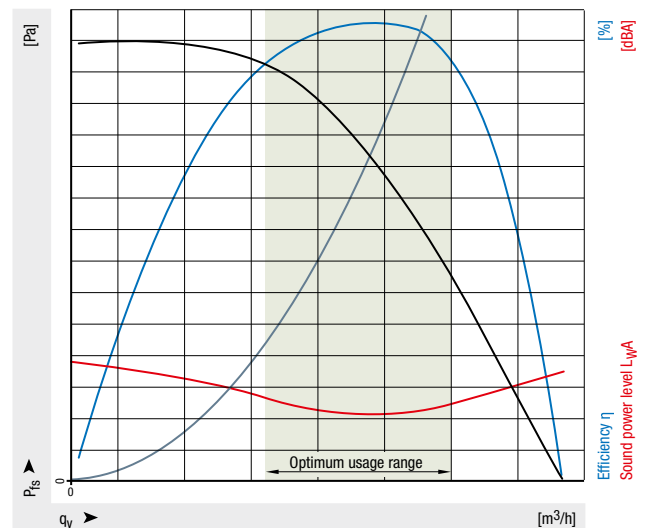

- Fan curve
- Efficiency curve
- Noise curve
- System or device curve
- Operating point
- Usage range

Selection of fans

The product catalogs contain all the relevant information on

– Product designation

The header defines the technology (AC or EC), the type (centrifugal, axial, ...), the series (e.g. S series), the impeller diameter and other features of the product.

– Product description

Depending on the product, the following items of information are presented here:

Material, number of blades, airflow direction, direction of rotation, degree of protection, insulation class, installation position, condensation drainage holes, mode of operation, bearings, technical features, EMC, touch current, motor protection, electrical hookup, cable/terminal box design, protection class, capacitor, conformity with standards, approvals and options.

– Nominal data

AC products (up to motor size 074) and EC products (with DC supply):

Free air/with minimum back pressure AC products (as of motor size 094) and EC products (with AC supply):
At the operating point with maximum load

– Order designation/type

An explanation of the order designation and type is given under Type code.

– Product drawing

– Operating points

The operating points with information on speed, power consumption, current draw, sound power level or sound pressure level and overall efficiency of the impeller are listed in the adjacent Operating point table.

– Curves

The air performance curves for the product are shown in the graph.

– Accessories

The appropriate accessories (e.g. inlet rings, guard grill, fan housings) and further information (e.g. the connection diagram) can be found on the page numbers given.

EC centrifugal fans – RadiPac

backward curved, Ø 500



- **Material:** Support bracket: Steel, painted black
Support plate and inlet ring: Sheet steel, galvanized
Impeller: Sheet aluminium
Rotor: Painted black
Electronics housing: Die-cast aluminium
- **Number of blades:** 5
- **Direction of rotation:** Clockwise viewed toward rotor
- **Degree of protection:** IP 55
- **Insulation class:** "F"
- **Installation position:** Shaft horizontal or rotor on bottom, rotor on top on request
- **Condensation drainage holes:** Rotor side
- **Mode:** Continuous operation (S1)
- **Mounting:** Maintenance-free ball bearings

Nominal data		Curve	Nominal voltage range	Frequency	Speed ¹⁾	Max. input power ²⁾	Max. input current ²⁾	Perm. ambient temp.	Weight	Techn. features and connection diagram
Type	Motor		VAC	Hz	rpm	kW	A	°C	kg	
*3G 500	M3G 150-FF	⊙	3-380-480	50/60	1910	3,45	5,30	-25...+40	24,3	P. 93 / M5
*3G 500	M3G 150-IF	⊙	3-380-480	50/60	2250	5,70	9,00	-25...+40	32,0	P. 92 / M3

Curves:

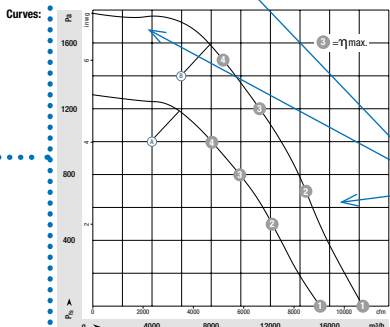

n rpm	P _{in} kW	I A	L _{WA} dB(A)
⊙ 1910	1,98	3,09	102
⊙ 1910	2,92	4,49	92
⊙ 1910	3,38	5,19	86
⊙ 1910	3,45	5,30	53
⊙ 2250	3,24	5,05	105
⊙ 2250	4,86	7,47	95
⊙ 2250	5,70	9,00	88
⊙ 2250	5,70	8,74	87

1) Performance measured according to ISO 5801, insulation category A, with open-ported inlet ring without contact protection.
2) Inlet-side sound level L_{WA}, according to ISO 12347, L_{WA} measured at 1 m distance from fan axis. The values given are only applicable under the specified measuring conditions and may differ depending on the installation conditions. In the event of deviation from the standard configuration, the accessories must be checked in installer condition. See Page 98 ff for detailed information.

- **Technical features:** See connection diagram P. 92 f.
- **EMC:**
 - Ⓢ Interference emission according to EN 61000-6-4
 - Ⓢ Interference emission according to EN 61000-6-3, except EN 61000-3-2 for professionally used equipment with a total rated power greater than 1 kW
 - Ⓢ Immunity to interference according to EN 61000-6-2
- **Touch current:** <= 3.5 mA according to IEC 60990 (measuring circuit Fig. 4)
- **Terminal box design:** electrical connection via terminal strip
- **Protection class:** I (with customer connection of protective earth)
- **Conformity with standards:** EN 61800-5-1, CE
- **Approvals:**
 - Ⓢ EAC
 - Ⓢ EAC, UIL, CSA
- **Efficiency:** Ecodesign EU regulation EU 327/2011

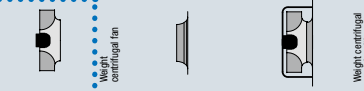

Centrifugal fan	kg	Inlet ring with one pressure tap	kg	Centrifugal module with support bracket	kg
R3G 500-PA23 -71	24,3	64025-2-4013		K3G 500-PA23 -71	38,7
R3G 500-PB33 -01	32,0	64025-2-4013		K3G 500-PB33 -01	48,0

K3G 500-PB33-01 (Centrifugal module with support bracket)

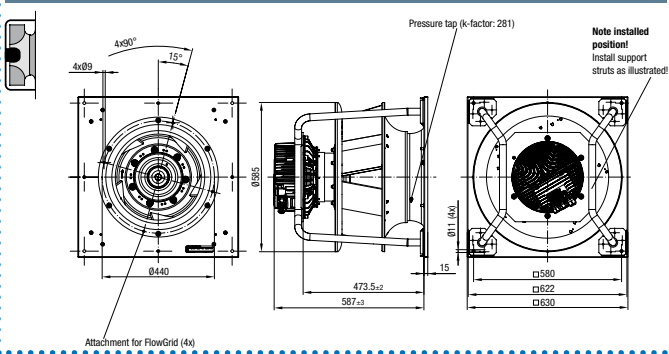

Drawings P. 48 ff.	FlowGrid air-inlet guard / Intake finger guard P. 20 f.	Inlet ring P. 82 ff.	Conn. diagram P. 92 f.	47
-----------------------	--	-------------------------	---------------------------	----

Information 0 250 0 280 0 310 0 355 0 400 0 450 0 500 0 560 0 630 0 710 0 800 0 900 Compact design Technology Agents

Centrifugal fans with backward-curved blades



Centrifugal fans with backward-curved blades

- **RadiCal:** One-piece impellers made of high-tech composite material, optimized flow control, combined with reliable asynchronous or high-efficiency GreenTech EC motors: These are the principal features of the new generation of backward-curved centrifugal fans for operation without scroll housing. They open up new perspectives, not just in ventilation and air conditioning technology: ebm-papst AC fans currently in use can be replaced with the latest fans featuring GreenTech EC technology without the need for expensive conversion work, for example.
- **RadiPac:** Stands for medium pressure centrifugal fans and identifies them as an independent product range alongside the RadiCal low-pressure product range. The name RadiPac is a reference to the term "packaged", meaning that: all the necessary functions are incorporated. This creates potential for further applications, not just in the air conditioning and ventilation industries. RadiPac fans are generally intended for operation without a scroll housing.
- **RadiFit:** Information on RadiFit centrifugal fans with backward-curved blades can be found in this section under "Centrifugal fans with scroll housing"



RadiCal



RadiPac



RadiFit

Centrifugal fans Product ranges

Product ranges

- **R series centrifugal fan:** Impeller with motor. Mounting on motor flange/stator bushing
- **K series centrifugal fan with support bracket:** Impeller with motor and support bracket. Mounting on support plate. Installation with vertical and horizontal motor shaft
- **K series centrifugal fan of cube design:** Impeller with motor and cube design. Mounting on support plate or cube structure. Installation with vertical and horizontal motor shaft



R series

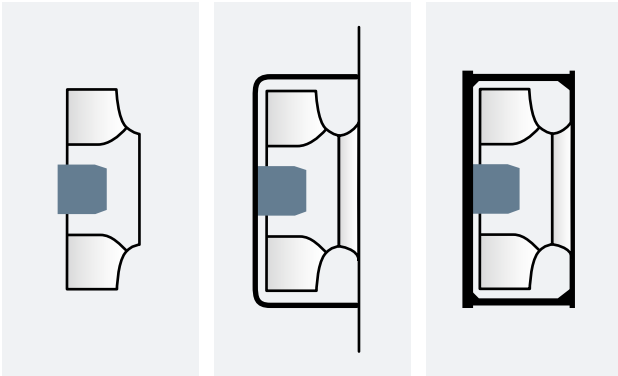

K series with support bracket



K series in cube design

Centrifugal fans Inlet ring

Air flow determination for inlet rings with pressure tap

The differential pressure method compares the static pressure upstream of the inlet ring with the static pressure in the inlet ring. The air flow can be calculated from the differential pressure (between the static pressures) on the basis of the following equation:

$$q_v = k \cdot \sqrt{\Delta p} \quad q_v \text{ in [m}^3\text{/h] and } \Delta p \text{ in [Pa]}$$

If the air flow is to be regulated to a constant level, the inlet ring pressure must be kept constant:

$$\Delta p = q_v^2 : k^2$$

k takes the specific properties of the inlet ring into account.

The pressure is tapped at 1 (4) point(s) on the circumference of the inlet ring.

Customer-side connection is made by way of a built-in T-shaped hose fitting. The hose fitting is suitable for pneumatic hoses with an inside diameter of 4 mm.

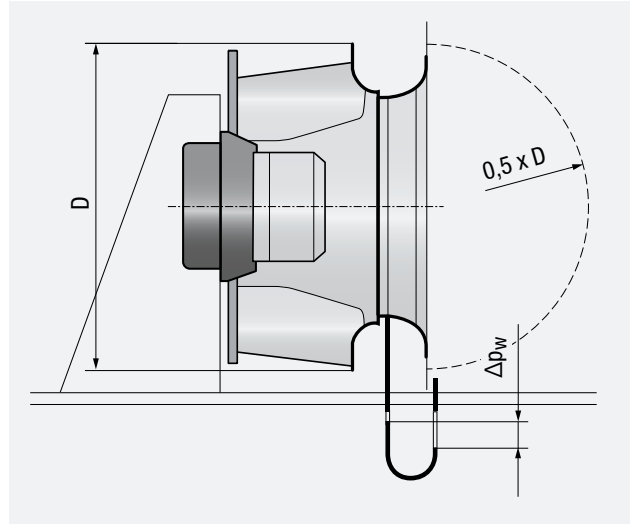

Centrifugal fans

Effects of air gap and overlap

Effects of changing the centrifugal air gap

The centrifugal air gap between the inlet ring and impeller cover plate influences the air performance and efficiency of a centrifugal fan.

A change in the inlet ring gap dimension influences the curve:

- ① $s/D = 0.4\%$
- ② $s/D = 1.0\%$
- ③ $s/D = 1.4\%$

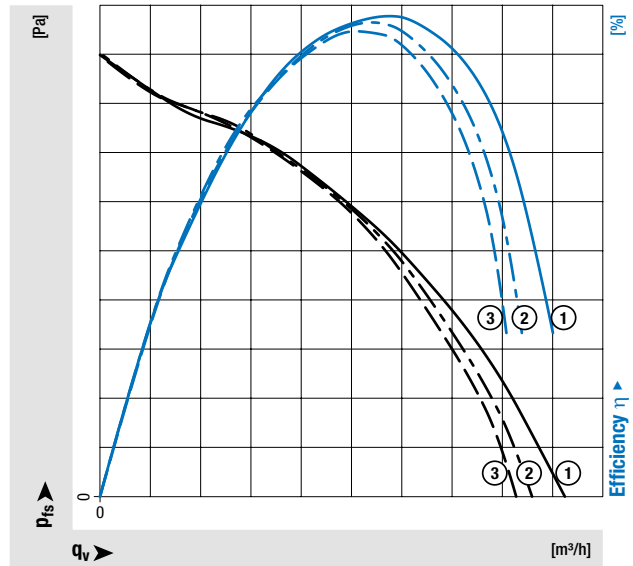
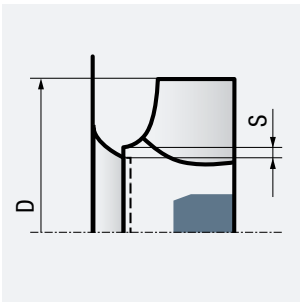

Effects of changing the axial overlap

The axial overlap between the inlet ring and impeller cover plate influences the air performance and efficiency of a centrifugal fan.

A change in the overlap influences the curve:

- ① $x/D = 0.6\%$
- ② $x/D = 0\%$
- ③ $x/D = -0.8\%$

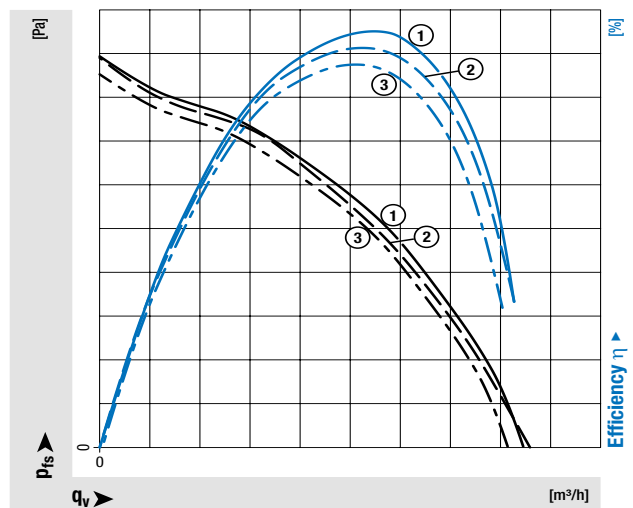
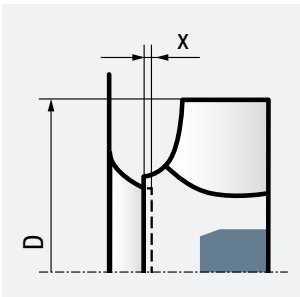

Centrifugal fans

Effects of intake obstructions

Effects of intake obstructions

Intake and outlet side obstructions reduce the air performance of centrifugal fans.

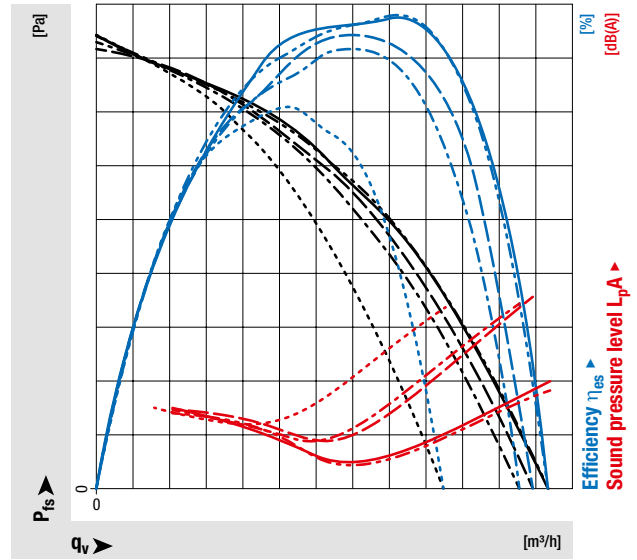
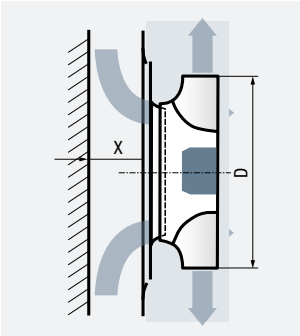

- $x / D = \infty$
- - - $x / D = 15\%$
- · - · $x / D = 40\%$
- · - · $x / D = 10\%$
- - $x / D = 20\%$

Centrifugal fans

Effects of installation space

Effects of installation space

Installation losses will occur if a centrifugal fan is fitted in a ventilation unit with too little space. The effect on the operating characteristics of the fan can be estimated from the curve shown. For boxes with a square cross-section, the hydraulic diameter is to be calculated from the width and height of the box and the value divided by the impeller diameter. The correction factor for the air flow can then be read off the graph on the basis of this value.

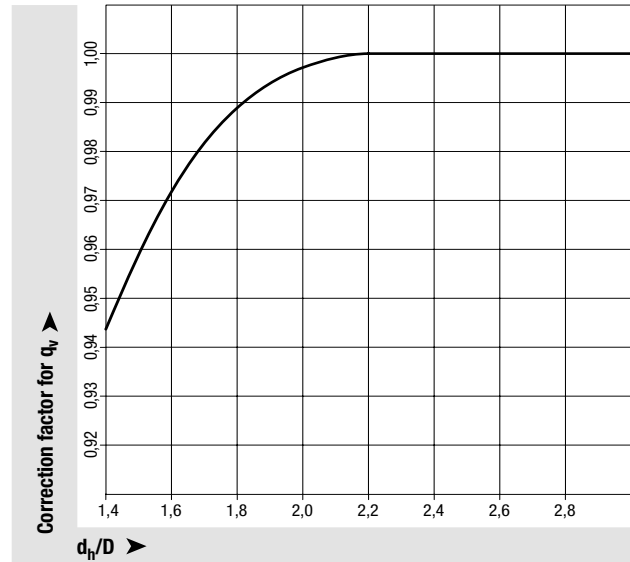
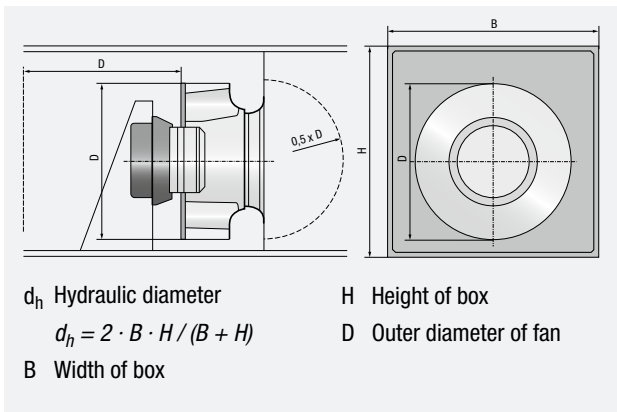

A FlowGrid helps to minimize the extra noise caused by a confined installation situation. There is then often less of a need for extensive secondary noise protection measures, if at all.

The FlowGrid is simply attached in the intake area of the centrifugal fan.



FlowGrid for centrifugal fans

Centrifugal fans with scroll housing



Centrifugal fans with scroll housing

- **RadiFit:** Our RadiFit centrifugal fan product range with scroll housing and backward-curved blades is the ideal system solution for a wide range of industrial and ventilation technology applications. With their highly efficient GreenTech EC motors they can offer excellent efficiency at high pressures. They are also extremely compact, light and robust.
- **D and G series:** Centrifugal fans with forward-curved blades are available in dual-inlet (D) or single-inlet (G) versions. The centrifugal blowers are suitable for virtually all conceivable applications, from compact air handling units, air curtains and fan coils to air heaters for factory buildings or cooling fans for the forced cooling of power converters, generators or telecommunications installations.
- **K series (combinations):** The ideal ventilation solution for fan coils and door air curtains. Thanks to highly efficient GreenTech EC technology, they are not only extremely inexpensive to operate but also completely reliable and fully maintenance free over an exceptionally long period of time – cutting the life cycle costs still further.



RadiFit

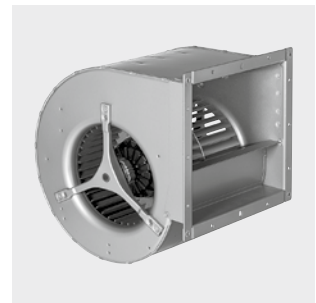

D series

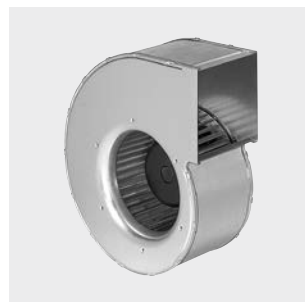

G series



K series

Centrifugal fans Impellers

Impellers

- **Sheet steel:** Sheet steel impellers are used in a wide range of applications. Their outstanding features are great stability and robustness.
- **Aluminum:** Being resistant to corrosion, aluminum impellers have a longer service life. They are also light and highly durable. Possible areas of application include industrial ventilation technology.
- **Plastic:** Plastic impellers are more versatile than metal impellers in terms of shape and are thus suitable for special air conditioning and ventilation technology applications. They are also corrosion-resistant.



Aluminum impeller

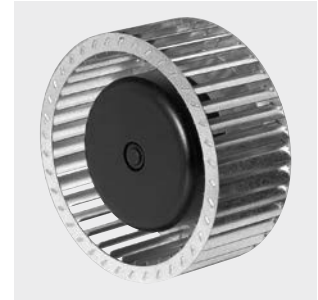

Sheet steel impeller



Plastic impeller

Direction of rotation

The housing position and direction of rotation for fans correspond to the EUROVENT directive.

The airflow direction is determined when viewed toward the drive side:

- Counter-clockwise = Direction of rotation "LG"
- Clockwise = Direction of rotation "RD"

Direction of rotation "LG"

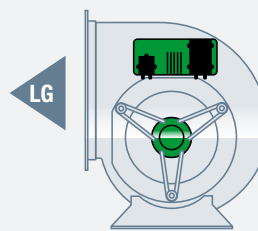

Direction of rotation "RD"

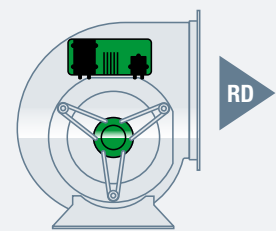

Housing position

The following housing positions are available for fans with mounting bracket or mounting frame.

Housing position

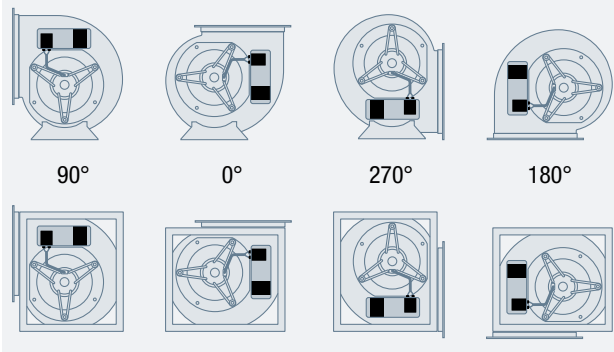



Centrifugal fans Scroll housing

Dimensioning of scroll housing for fans

The size is determined by the impeller diameter in millimeters or inches. Fans are also classified on the basis of nominal sizes in accordance with DIN 323 series of standards R20.

The dimensions of a typical scroll housing can be calculated with the following formulas based on the impeller diameter D:

Adjustment of the dimensions to suit smaller spaces is possible. We would be pleased to offer you our assistance.

 Centrifugal impeller with forward-curved blades		 Centrifugal impeller with backward-curved blades	
A	$1.062 \cdot D$	A	$1.10370 \cdot D$
B	$0.992 \cdot D$	B	$1.01625 \cdot D$
C	$0.922 \cdot D$	C	$0.93573 \cdot D$
D	$0.853 \cdot D$	D	$0.86159 \cdot D$
E	$0.784 \cdot D$	E	$0.79332 \cdot D$
F	$0.715 \cdot D$	F	$0.73046 \cdot D$
G	$0.646 \cdot D$	G	$0.67258 \cdot D$
H	$0.612 \cdot D$	H	$0.62500 \cdot D$
J	$0.720 \cdot D$	J	$0.77000 \cdot D$
K	$0.689 \cdot D$	K	$0.70195 \cdot D$
R	$0.073 \cdot D$	R	$0.10000 \cdot D$

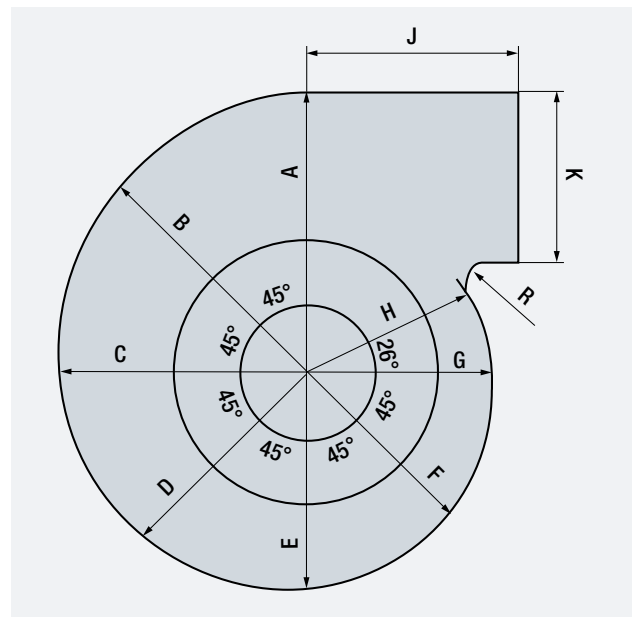

Centrifugal fans Versions

Connection flange

The scroll housings are fitted with a connection flange as standard. The flange makes it easy to install pipes or attach the fan to corresponding walls.

The design of the connection flanges differs depending on the fan product range



Product ranges

- **RadiFit:** Centrifugal impeller with backward-curved blades, dual-inlet scroll housing, EC external rotor motor integrated into fan impeller, external electronics. With mounting bracket or mounting frame.
- **D product range:** Centrifugal impeller with forward-curved blades, dual-inlet scroll housing, AC or EC external rotor motor integrated into fan impeller, external electronics.
- **G product range:** Centrifugal impeller with forward-curved blades, single-inlet scroll housing, AC external rotor motor integrated into fan impeller.
- **K series (combinations):** Centrifugal w with forward-curved blades, dual-inlet scroll housing, external rotor motor integrated into fan impeller.

Available as combination in twin or triple design for example.

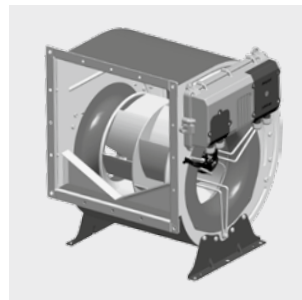

RadiFit with mounting bracket

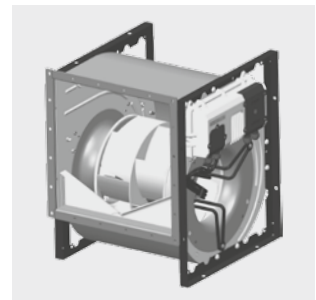

RadiFit with mounting frame

Centrifugal fans

Effects of intake obstructions

Effects of intake obstructions

Intake-side obstructions reduce the air performance of centrifugal blowers.

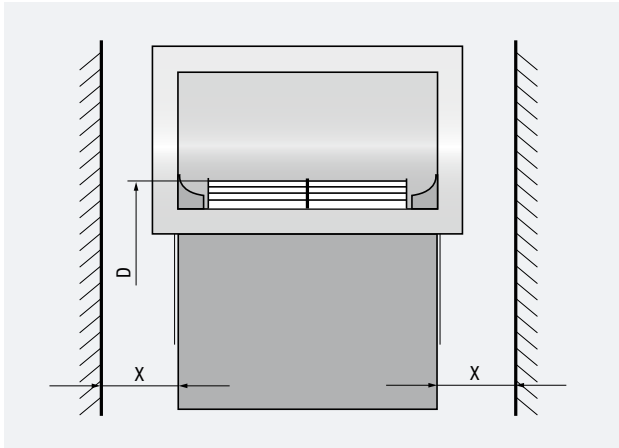

1 $x / D = \infty$ 2 $x / D = 30\%$ 3 $x / D = 23\%$
 4 $x / D = 15\%$ 5 $x / D = 7.5\%$

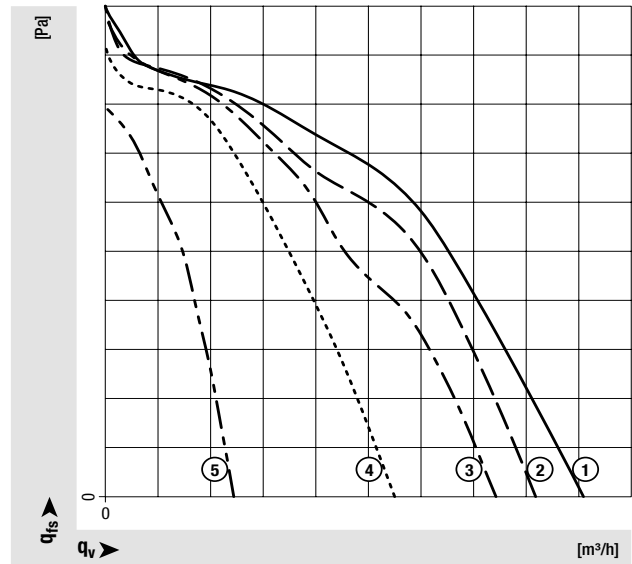

Effects of intake obstructions with constant-volume operation

A constant volume is only achieved if there are no inflow obstructions. Obstructed (e.g. asymmetrical or partially blocked) inflow can significantly affect the curve and produce considerable deviations from a constant-volume curve.

Notes on how to obtain a sufficiently unobstructed inflow:

- The distance x between the blower intake and limiting walls or obstructions should be equal to at least 25% of the impeller diameter.
- Inflow swirl or rotationally asymmetric inflow should be avoided.
- Intake-side resistances such as filters or grills even out the inflow.

On request we can supply calibrated blower versions optimized for specific installation situations.

Examples of obstructed inflow

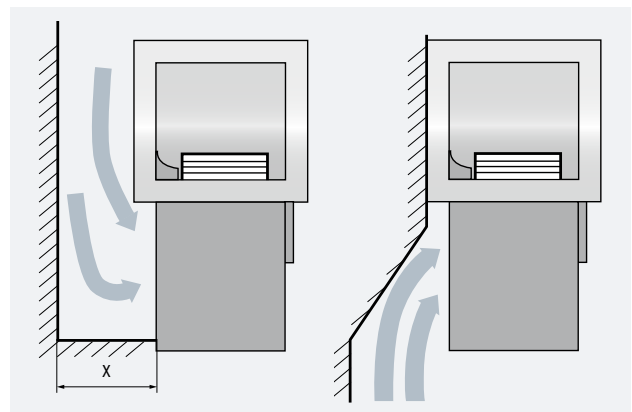

Centrifugal fans Stepped diffuser

Effects of stepped diffuser

A diffuser with connected outlet duct attached on the discharge side increases the air performance and efficiency of centrifugal blowers.



① Without stepped diffuser



② With stepped diffuser

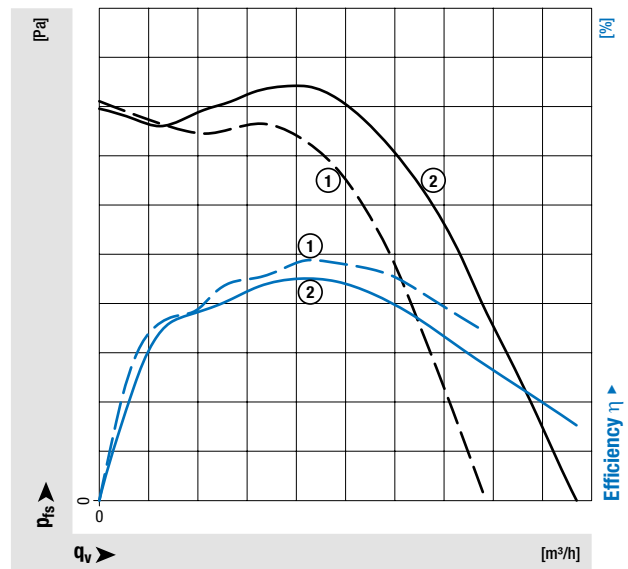



Diagonal fans



Diagonal fans

Diagonal fans are the preferred choice for high air performance in a confined space. Functions provided include:

- Temperature control
- Active motor cooling
- Filter monitoring with signal output for filter replacement

The facts at a glance:

- Wide range of motors for diagonal fans:
- AC or DC motors
- Internal or external rotor
- Mechanical or electronic commutation
- EC motor with integrated or external operating electronics
- Drive units capable of communication with bus interface

Diagonal fans Performance ranges

Optimum usage range

Immediately to the right of the dip
(right section of the air performance curves):

- Maximum efficiency
- Minimum noise

To the left of the dip (left section of the air performance curves):

- Stalling
- Falling efficiency
- Abrupt increase in noise

The operating point of a diagonal fan is between that of axial and centrifugal fans.
The optimum usage range of the fan is highlighted in green in the adjacent graph.

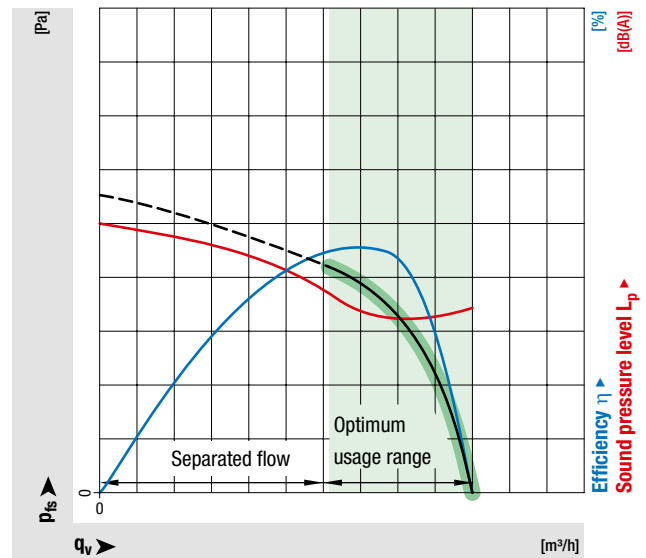

- Fan curve
- Efficiency curve
- Noise curve
- System or device curve
- Operating point
- Usage range

Selection of fans

The product catalogs contain all the relevant information on

– Product designation

The header defines the technology (AC or EC), the type (centrifugal, axial, ...), the series (e.g. S series), the impeller diameter and other features of the product.

– Product description

Depending on the product, the following items of information are presented here:

Material, number of blades, airflow direction, direction of rotation, degree of protection, insulation class, installation position, condensation drainage holes, mode of operation, bearings, technical features, EMC, touch current, motor protection, electrical hookup, cable/terminal box design, protection class, capacitor, conformity with standards, approvals and options.

– Nominal data

AC products (up to motor size 074) and EC products

(with DC supply):

Free air/with minimum back pressure AC products

(as of motor size 094) and EC products (with AC supply):

At the operating point with maximum load

– Order designation/type

An explanation of the order designation and type is given under Type code.

– Product drawing

– Operating points

The operating points with information on speed, power consumption, current draw, sound power level or sound pressure level and overall efficiency of the impeller are listed in the adjacent Operating point table.

– Curves

The air performance curves for the product are shown in the graph.

– Accessories

The appropriate accessories (e.g. inlet rings, guard grill, fan housings) and further information (e.g. the connection diagram) can be found on the page numbers given.

Max. 1100 m³/h
S-Force

DC diagonal fan
Ø 172 x 51 mm



- **Material:** Housing: Die-cast aluminum
Impeller: GRP® (PA)
- **Direction of air flow:** Exhaust over struts
- **Direction of rotation:** Counterclockwise, looking towards rotor
- **Connection:** (+) and GND: AWG 18, UL 1007, TR 64; speed and alarm signal: AWG 22, UL 1007, TR 64
- **Highlights:** Highly efficient and smoothly operating 3-phase fan drive
Housing with grounding lug for screw M4 x 8 (Forx)
- **Weight:** 1050 g
- **Possible special versions:** (See chapter DC fans - specials)
 - Speed signal
 - Go / NoGo alarm
 - Alarm with speed limit
 - External temperature sensor
 - Internal temperature sensor
 - PWM control input (standard)
 - Analog control input
 - Multi-option control input
 - Moisture protection
 - Salt spray protection
 - Degree of protection: IP 54

Series DV 6300 TD

Nominal data	Air flow		Nominal voltage	Voltage range	Sound pressure level	Sound power level	Static sleeve bearings Ball bearings	Power consumption	Nominal speed	Temperature range	Service life L ₁₀ (40 °C) em-papst standard	Service life L ₁₀ (C _{em}) em-papst standard	Life expectancy L ₁₀ (40 °C) see page 17	Curve
	m ³ /h	cfm												
DV 6318/2 TDHP*	630	371	48	36...72	68	7.6	■	75	4000	-20...+65	70 000 / 40 000		117 500	①
DV 6318/2 TDHHP*	770	453	48	36...72	73	8.0	■	135	4900	-20...+65	60 000 / 32 500		102 500	②
DV 6318/2 TDHAP	1050	617	48	36...72	77	8.7	■	300	6500	-20...+65	50 000 / 27 500		85 000	③
DV 6318/2 TDHSP*	1100	647	48	36...72	79	8.9	■	360	6800	-20...+65	40 000 / 22 500		67 500	④

* On request
** Rotor protection
a = 3 mm

Speed control range from 1000 rpm⁻¹ up to maximum nominal speed. Standstill at 0% PWM, maximum speed if control cable is interrupted.
The fan has an acceleration of up to 30% that produces a smoother curve.

n rpm ⁻¹	P _{ref} W	L _{WA} dB(A)	L ₁₀ (40 °C)	L ₁₀ (65 °C)	L ₁₀ (40 °C)	L ₁₀ (65 °C)	L ₁₀ (40 °C)	L ₁₀ (65 °C)	L ₁₀ (40 °C)	L ₁₀ (65 °C)
① 14000	65.5	79	70 000	40 000	117 500					
② 3835	64.5	78	72 500	40 000	122 500					
③ 3815	64.5	76	75 000	42 500	127 500					
④ 3930	65	76	77 500	42 500	130 000					
⑤ 4210	66	79	77 500	42 500	130 000					
⑥ 4890	120	83	60 000	32 500	102 500					
⑦ 4690	119	82	67 500	37 500	115 000					
⑧ 4670	119	80	72 500	40 000	122 500					
⑨ 4870	120	81	75 000	42 500	127 500					
⑩ 5190	121	85	75 000	42 500	127 500					
⑪ 6500	280	90	50 000	27 500	85 000					
⑫ 6230	275	89	62 500	35 000	105 000					
⑬ 6200	280	88	70 000	40 000	117 500					
⑭ 6450	281	88	72 500	40 000	122 500					
⑮ 6900	283	92.5	72 500	40 000	122 500					
⑯ 6950	345	92	40 000	22 500	67 500					
⑰ 6720	345	91	57 500	32 500	97 500					
⑱ 6630	345	89.5	62 500	35 000	105 000					
⑲ 6850	345	89	67 500	37 500	115 000					
⑳ 7300	345	94	72 500	40 000	122 500					

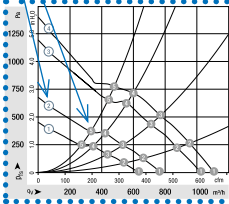

Air performance measured according to: ISO 5801
Installation category A, without contact protection.
Figure: Total sound power level L_w ISO 10302
measured on a hemisphere with a radius of 2 m.
Sound pressure level L_p measured at 1 m distance from the axis.
The values given are applicable only under the specified measuring conditions and may differ depending on the installation conditions.
In the event of deviation from the standard configuration, the parameters must be checked after installation.
For detailed information see <http://www.ebmpapst.com/general-conditions>

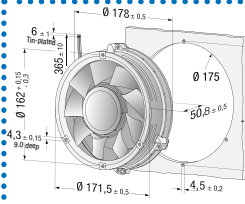

Diagonal fans Impellers

Product ranges

- **W series:** Diagonal fan of axial design with aerodynamically optimized plastic impeller, fan housing made of robust die-cast aluminum. Integrated EC motor.
- **DV series:** Diagonal fan of axial design with integrated DC motor and fan housing made of glass-fiber reinforced plastic or die-cast aluminum.
- **K series:** Diagonal fan of centrifugal design as module with inlet ring. Mounting plate, inlet ring and motor suspension element are made of robust, resilient plastic. The uncompromising aero-acoustic design is an outstanding advantage.



W series



DV series



K series

Installation information

The conical housing included in the scope of delivery ensures the necessary gap dimension.

Effects

The effects are comparable to those of an axial fan (See Page 55).

Diagonal fans

Effects of intake and outlet obstructions

Effects of intake obstructions

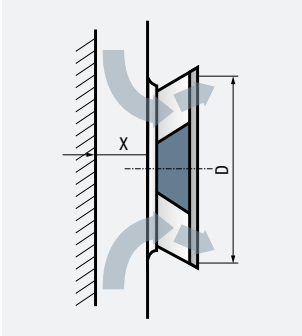

- $x / D = \infty$
- - - $x / D = 40\%$
- - - $x / D = 20\%$
- - - $x / D = 15\%$
- ... $x / D = 10\%$

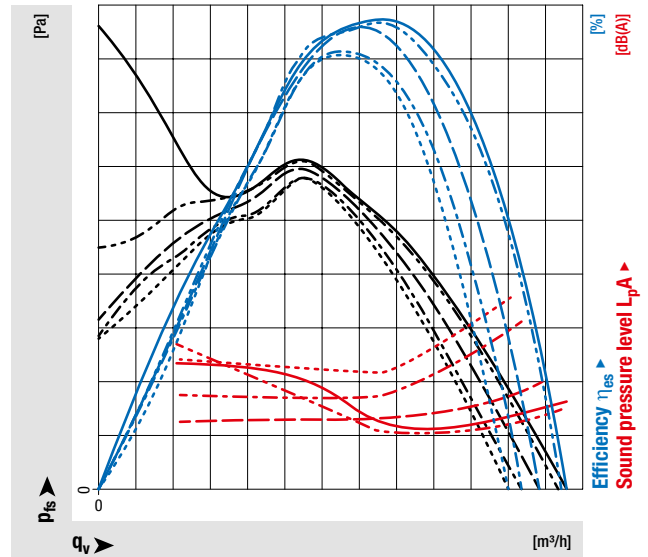

Effects of outlet obstructions

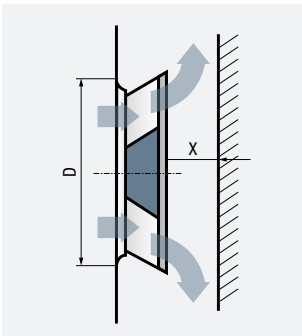

- $x / D = \infty$
- - $x / D = 50\%$
- ... $x / D = 25\%$

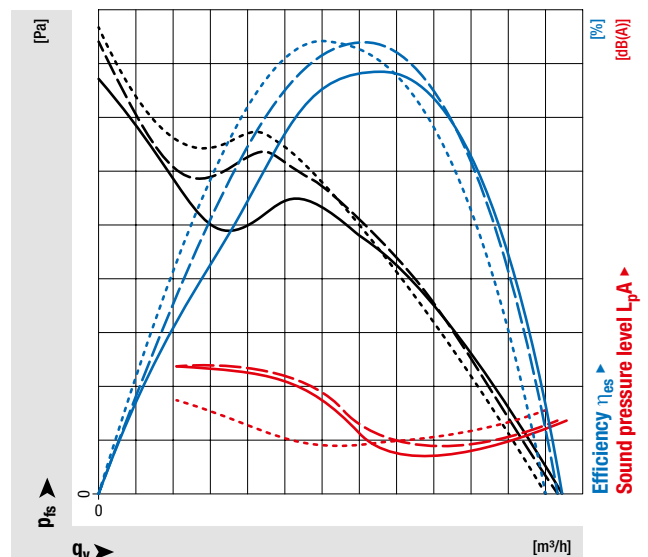



Tangential blowers



Tangential blowers

Stove jacket cooling, storage heaters, wood-burning stoves, underfloor convectors, tanning beds, air conditioners and heaters – common to all these applications is the need for a ventilation system of shallow design with high air flow rates.

The ideal solution: Tangential blowers from ebm-papst.

These provide high air flow rates and extremely good noise characteristics.

The facts at a glance:

- Low noise with high air flow rates and low back pressures
- High air throughput with low flow velocities
- Expanded-width discharge area ensures that air makes good contact with ducts and surfaces to be cooled
- Extremely shallow design
- Moisture-proof versions for refrigeration applications for example
- Higher speeds with GreenTech EC motors than with AC motors
- Power adjustment via PWM signal or 0–10 V analog voltage

Tangential blowers Performance ranges

Optimum usage range

In the last right third of the air performance curve:

- Max. efficiency
- Minimum noise

Left area of the air performance curve:

- Unstable behavior due to stalling
- Poor efficiency
- Slightly increasing noise level

The operating range is at much lower pressures than with all other fans.

The optimum operating range is highlighted in green in the adjacent graph.

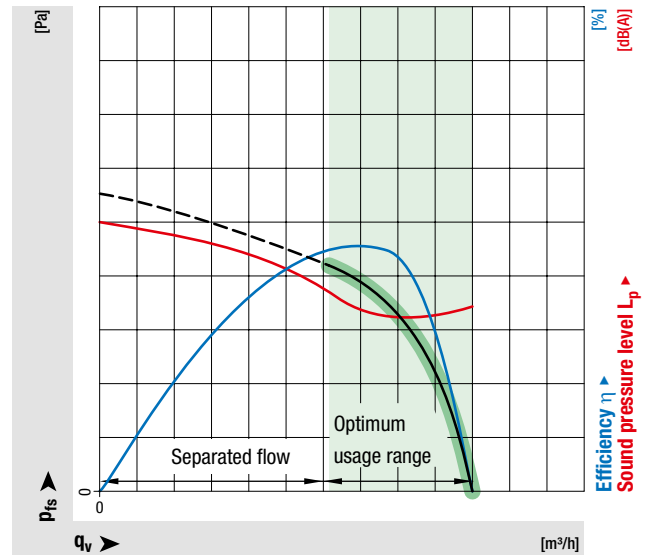

- Fan curve
- Efficiency curve
- Noise curve
- System or device curve
- Operating point
- Usage range

Selection of fans

The product catalogs contain all the relevant information on

– Product designation

The header defines the technology (AC or EC), the type (centrifugal, axial, ...), the series (e.g. S series), the impeller diameter and other features of the product.

– Product description

Depending on the product, the following items of information are presented here:

Material, number of blades, airflow direction, direction of rotation, degree of protection, insulation class, installation position, condensation drainage holes, mode of operation, bearings, technical features, EMC, touch current, motor protection, electrical hookup, cable/terminal box design, protection class, capacitor, conformity with standards, approvals and options.

– Nominal data

AC products (up to motor size 074) and EC products (with DC supply):

Free air/with minimum back pressure AC products (as of motor size 094) and EC products (with AC supply):

At the operating point with maximum load

– Order designation/type

An explanation of the order designation and type is given under Type code.

– Product drawing

The air performance curves for the product are shown in the graph.

– Connection diagram

The connection diagrams show the connections for power supply and interface.

The compatible connectors are also given.

QL 100



Tangential blowers with electronically commutated direct current motors

- With external commutation electronics
- Vibration-cushioned suspension
- Blower speed adjustable through PWM signal, or through 0 -10 V analog voltage signal (see page 7)
- Impeller diameter: 100 mm
- Mounting position: horizontal; vertical with motor on the bottom on request
- Permissible ambient temperature electronics: 0 - 50 °C
- Degree of protection: IP00 (electronics), IP54 (motor) possible
- Protection class I
- Overload protected by software class B
- Controlled speed

Nominal data		Characteristic curve	Nominal voltage (AC)	Air flow	Max. pressure increase	Max. power input	Speed	Permissible ambient temperature (motor)	Permissible medium temperature	Dimensions in mm		
Type	Part number									V	m ³ /h	Pa
QL100/5000-8G4320	55669.11010	1	220-240	1075	75	80	1500	0 - 60	-15 - 80	836	560	520
QL100/6000-8G4320	55669.12010	2	220-240	1200	75	80	1500	0 - 60	-15 - 80	736	660	620
QL100/7000-8G4320	55669.13010	3	220-240	1300	75	80	1500	0 - 60	-15 - 80	836	760	720
QL100/8000-8G4320	55669.14010	4	220-240	1360	75	80	1500	0 - 60	-15 - 80	936	860	820

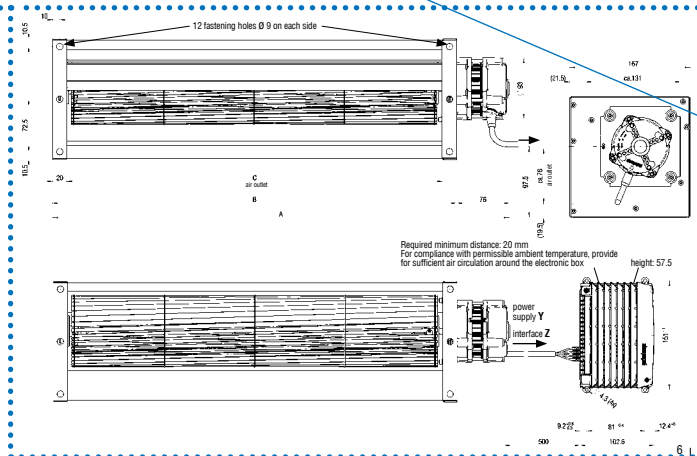

Characteristic curve, electrical interfaces and connectors

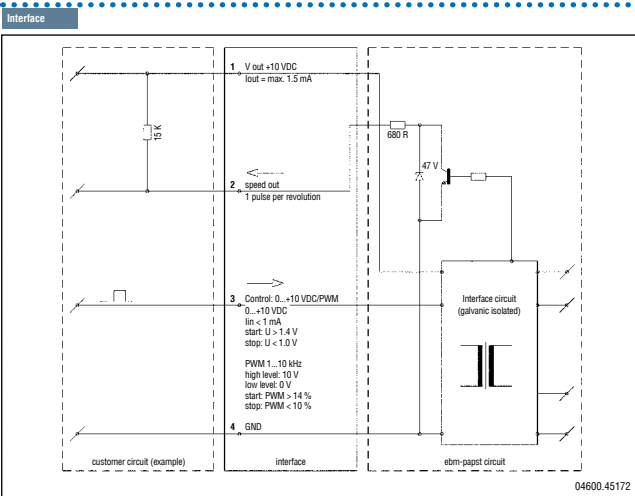

Power supply Y
Coding of the PCB fits to edge connector:
e.g. MFW9590-03-EFG5-000-960-000-00 (Fa. Stocko)
Part number for mating connector: 24310.45065

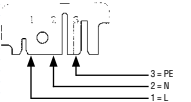

Interface Z
Coding of the PCB fits to edge connector:
e.g. MFW7238-004-061-960-000-00-G (Fa. Stocko)
Part number for mating connector: 24310.45066

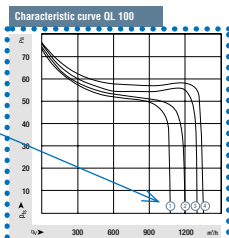
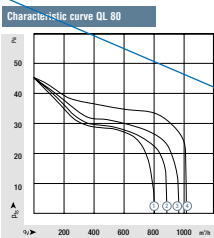
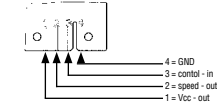



Motors

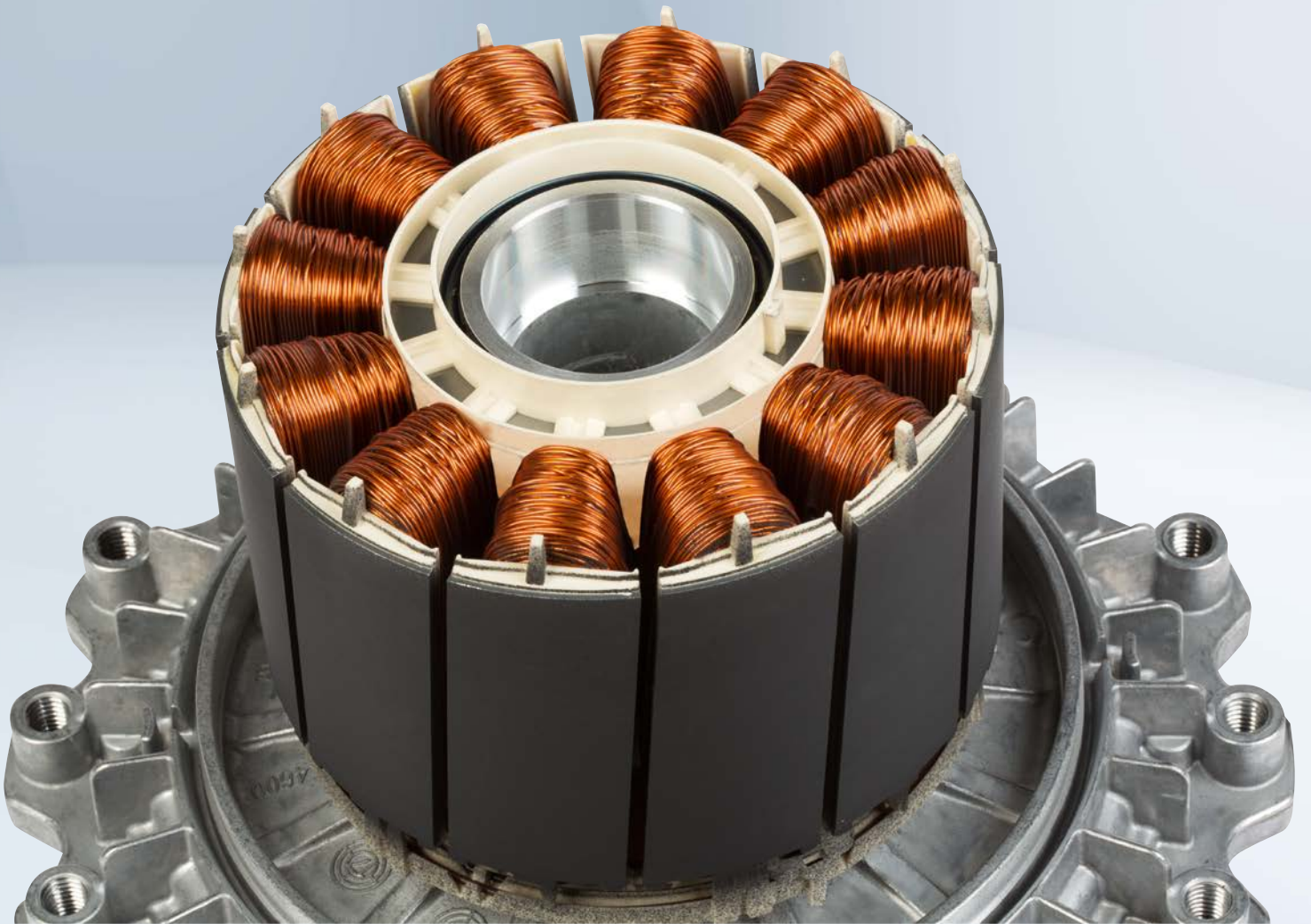

Motors from ebm-papst

Motors from ebm-papst with both AC and EC technology are based on the successful external rotor principle, which means that the rotor rotates around the internal stator.

This offers a variety of advantages:

- Space-saving design thanks to integrated bearings and direct installation in impeller
- Reduced load on the bearings as a result of more accurate balancing, as all rotating elements are permanently connected to one another
- Longer service life, as the motor-impeller unit is located directly in the air flow
- ebm-papst motors employing GreenTech EC technology attain optimum values in terms of efficiency and noise characteristics.

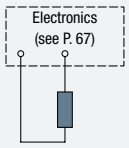
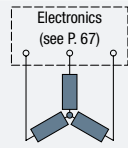
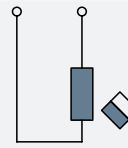
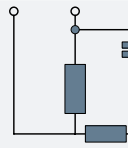
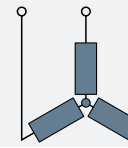
Features	EC motors		AC motors		
	Single-phase motor	Three-phase motor	Shaded-pole motor	Single-phase capacitor motor	Three-phase motor
1-phase AC voltage	Yes	Yes	Yes	Yes	In some cases (Steinmetz circuit)
3-phase AC voltage	No	Yes	No	No	Yes
DC voltage connection	Yes	Yes	No	No	No
Block diagram of stator					
Rotor principle	Magnetic rotor	Magnetic rotor	Squirrel-cage rotor	Squirrel-cage rotor	Squirrel-cage rotor
Efficiency	Very good	Very good	Low	Medium	Good
Integrated infinitely variable speed setting	Yes	Yes	No	No	No
Noise characteristics	Medium	Very good	Medium	Good	Very good

Efficiency levels of EC and AC motors without variable frequency drive

EC external rotor motors, used for example as drive units in energy-efficient fans, are not subject to the ErP implementing regulations no. 2009/640/EC of the European Union.

Their efficiency levels can however be compared to the values demanded by the directive. Such comparison reveals that the EC motors far surpass the efficiency level specified in this.

EC motor technology is thus the better alternative when planning energy-efficient devices and installations.

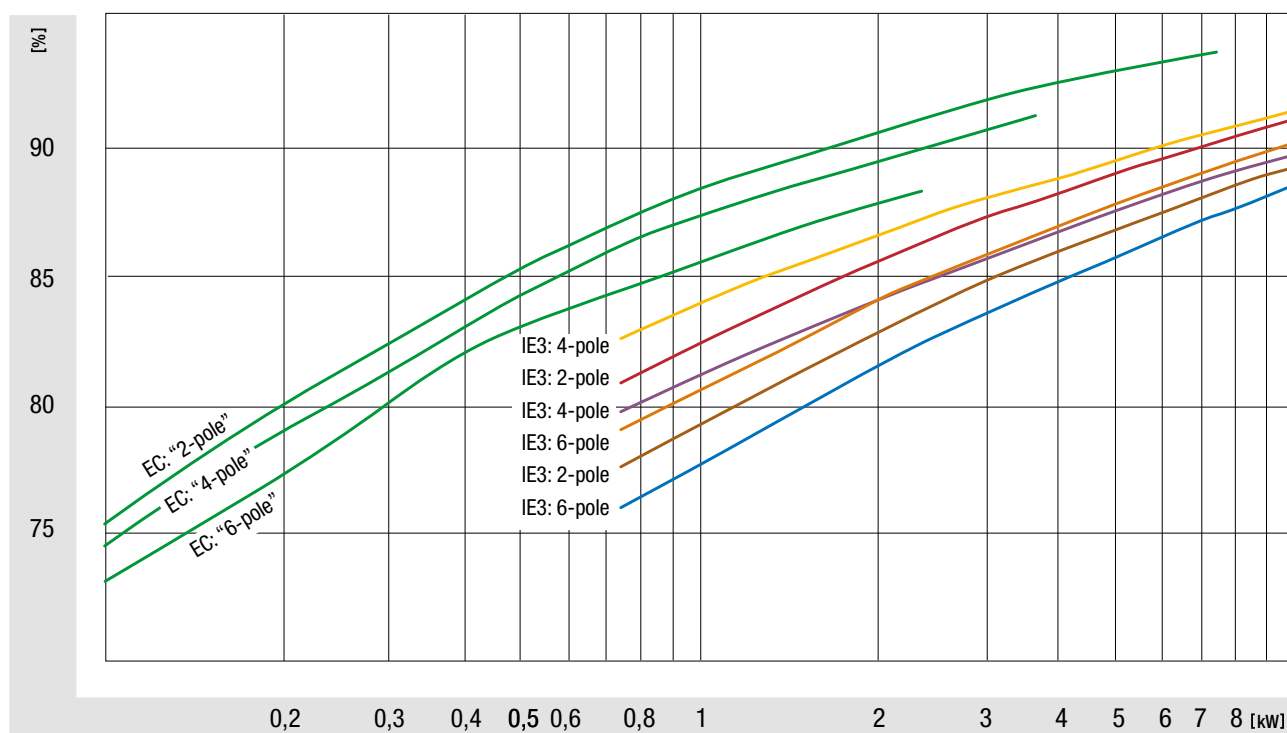

EC motors from ebm-papst

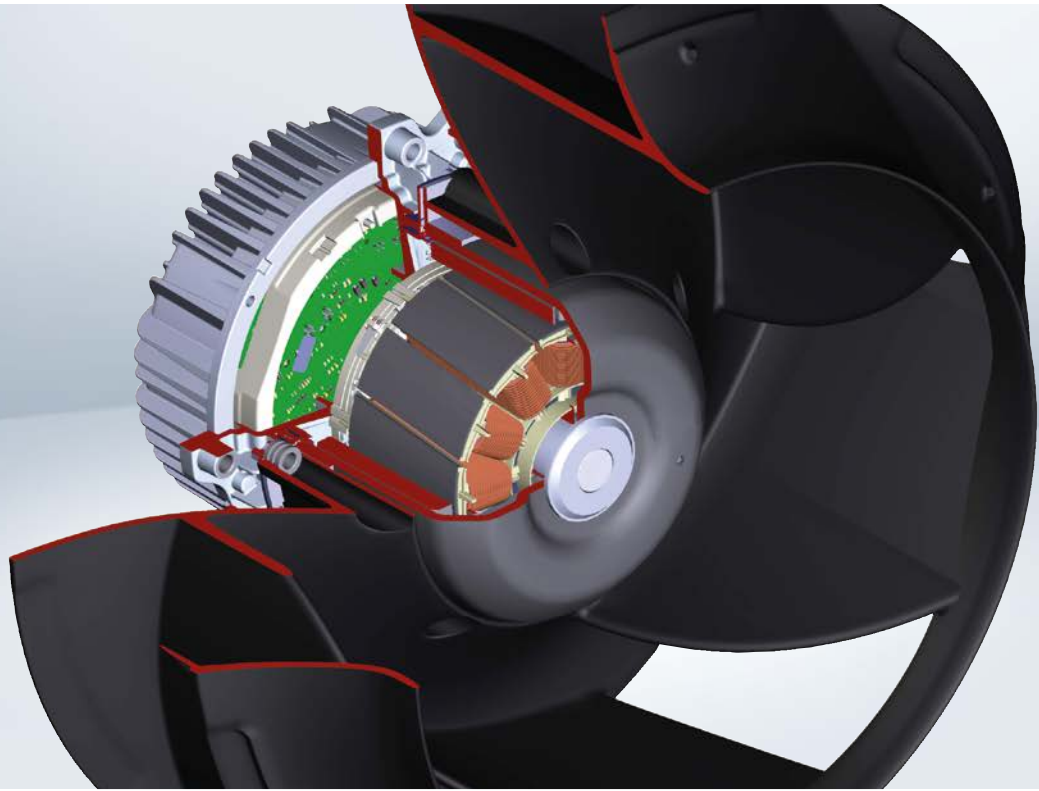

Torque curves of motor types

EC motor operation is based on the principle of synchronous rotation of the stator rotating field and the rotor.

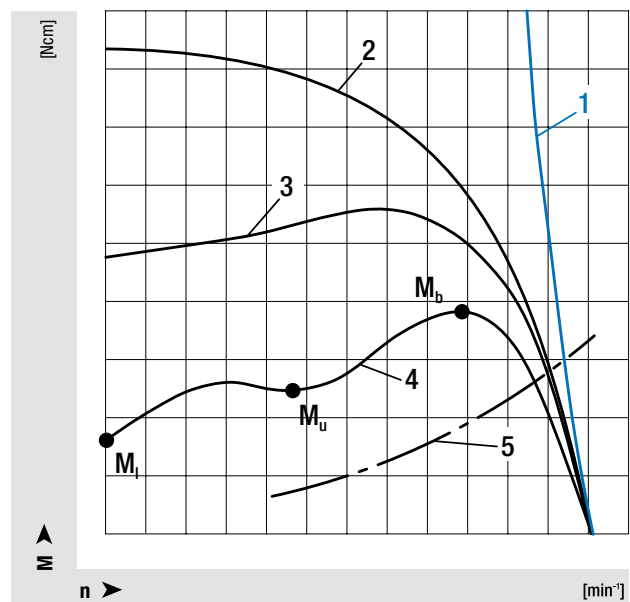

- 1 – EC motor
- 2 – Three-phase motor
- 3 – Single-phase motor
- 4 – Shaded-pole motor
- 5 – System curve
- M_l – Starting torque
- M_u – Saddle torque
- M_b – Breakdown torque

Single-phase motor

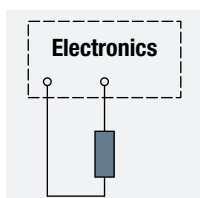

Benefits:

- Integrated speed setting
- Efficiency between 50% and 80% (depending on motor size)
- Long service life

Three-phase motor

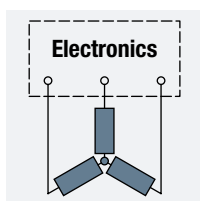

Benefits:

- Integrated speed setting
- Good efficiency between 60% and 90% (depending on motor size)
- Long service life
- Very good vibration and noise characteristics even in open-loop control operation
- Suitable for use as drive motor

AC motors from ebm-papst

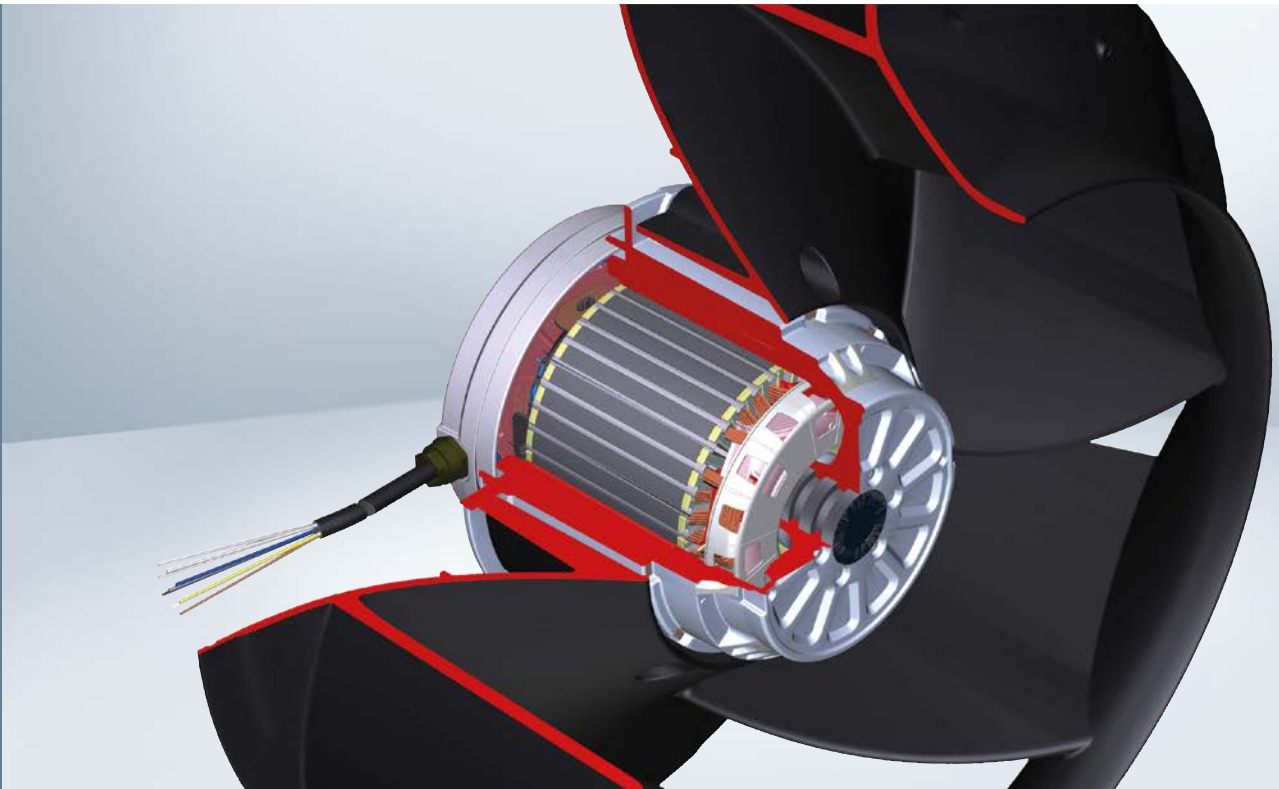

Torque curves of motor types

AC motor (induction motor) operation is based on the principle of asynchronous rotation of the stator rotating field and the rotor.

Starting current

The starting current of AC motors from ebm-papst is a maximum of 4 times higher than the specified nominal current.

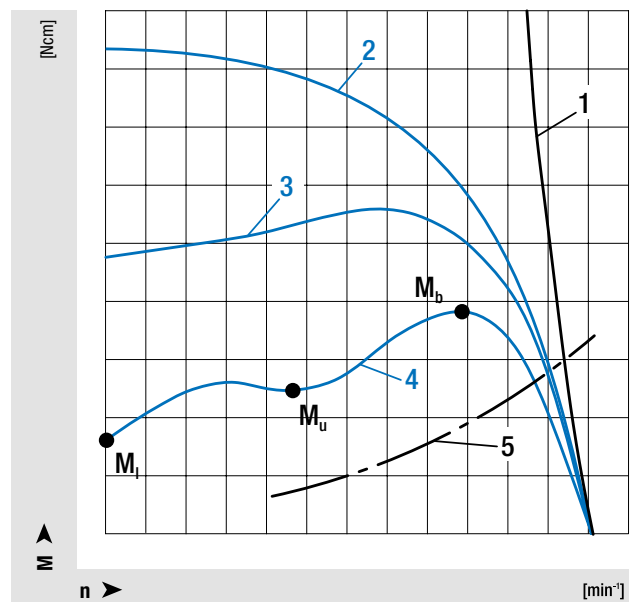

- 1 – EC motor
- 2 – Three-phase motor
- 3 – Single-phase motor
- 4 – Shaded-pole motor
- 5 – System curve

- M_l – Starting torque
- M_u – Saddle torque
- M_b – Breakdown torque

Shaded-pole motor

Each pole of the motor is electromagnetically split into a main and an auxiliary pole by a shading coil to produce a starting torque.

ebm-papst shaded-pole motors are available in 2-pole or 4-pole symmetrical external or internal rotor design.

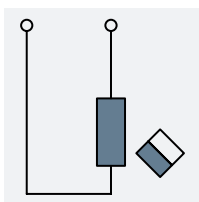

Benefits:

- Extremely robust motor design thanks to a cast squirrel-cage rotor and a stable bearing system
- Low-cost motor
- Extremely simple connection
- Long service life

Single-phase capacitor motor

Two windings (main winding and auxiliary winding) produce the rotating field of a single-phase capacitor motor by way of a capacitor connected in series with the auxiliary winding.

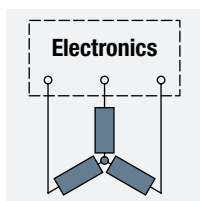

Benefits:

- Extremely robust motor design thanks to a cast squirrel-cage rotor and a stable bearing system
- Numerous speed setting options
- Efficiency between 30% and 75% (depending on motor size)
- Long service life
- Good vibration and noise characteristics

AC motors from ebm-papst

Three-phase motor torque curves

The three motor phases, differing by 120 electrical degrees, produce a circularly rotating field on connection to a three-phase supply.

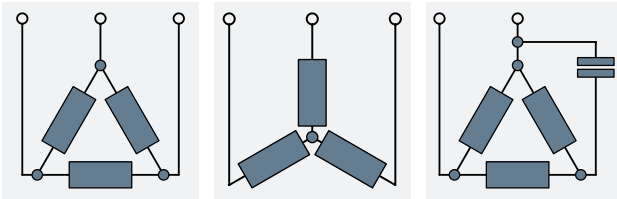

Delta connection

Star connection

Steinmetz circuit

Benefits:

- Extremely robust motor design thanks to a cast squirrel-cage rotor and a stable bearing system
- Very good vibration and noise characteristics
- Efficiency between 40% and 80% (depending on motor size)
- Extremely long service life

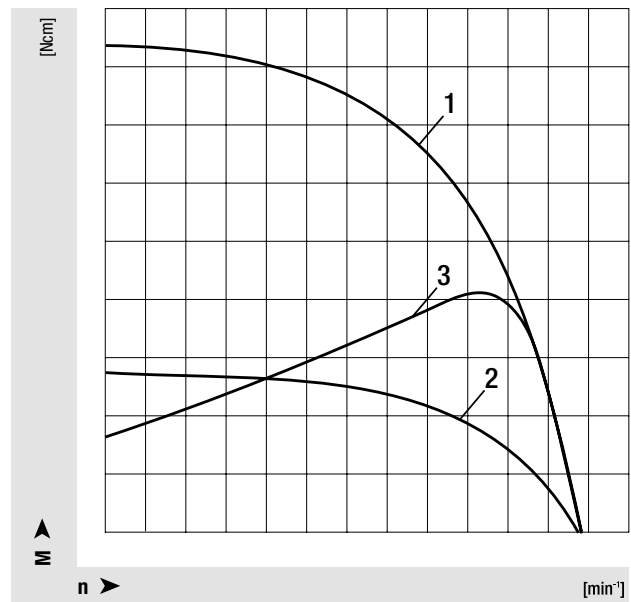

1 – Delta

2 – Star

4 – Steinmetz circuit



Control electronics from ebm-papst

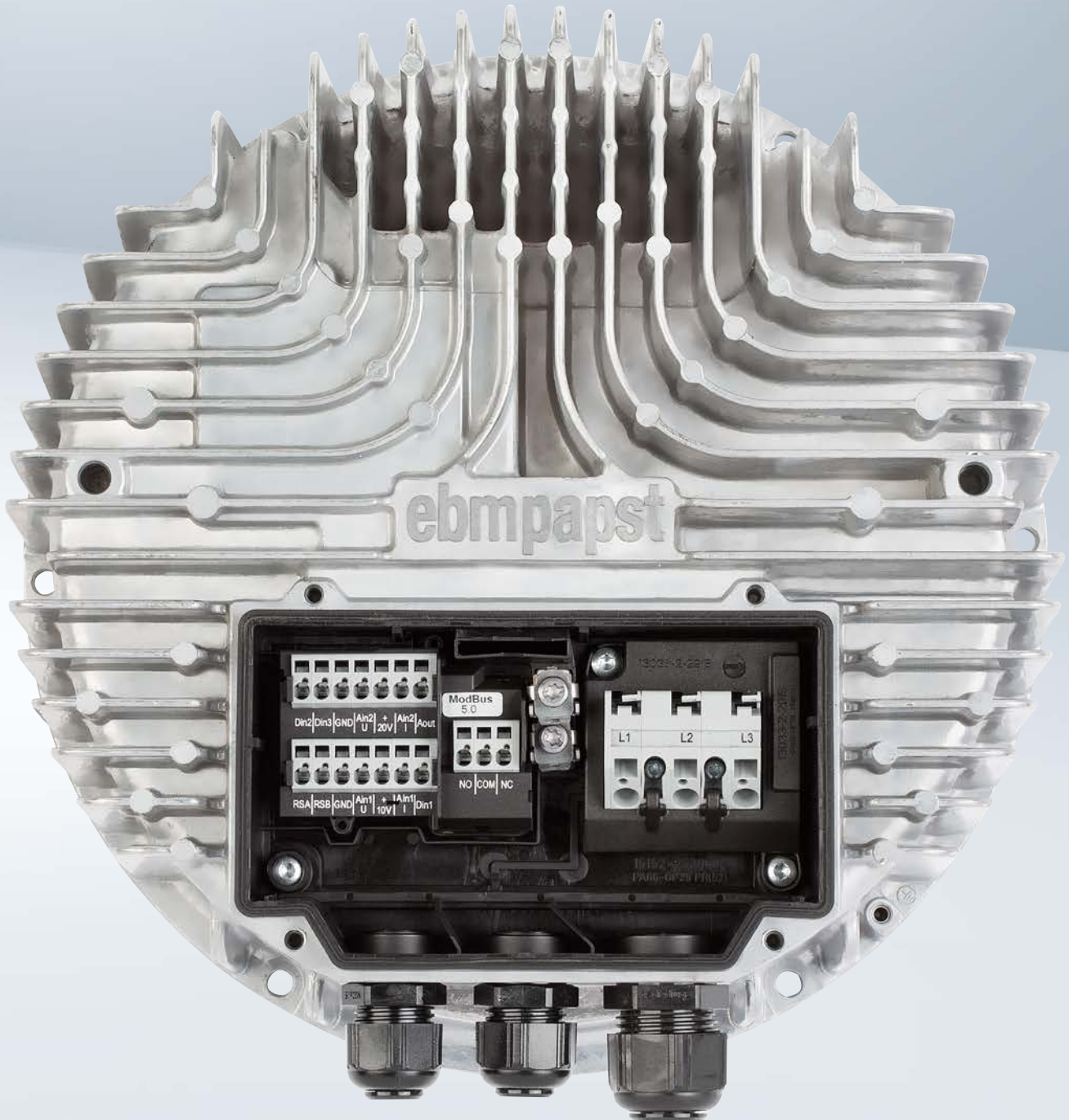

Control electronics from ebm-papst

Open and closed-loop control with technology from ebm-papst

The speed of the fans has to be adapted to suit the area of application. With AC technology, speed setting often involves more installation work and is typically associated with both unfavorable noise characteristics and higher power consumption.

EC technology from ebm-papst is the more ecological, less expensive alternative. The EC motor with integrated commutation electronics is highly efficient over the entire speed range and offers optimum noise characteristics with only a minimum of installation work.

Features	EC commutation electronics			AC					
	Integrated	Integrated with switched-mode power supply	External	Series resistor	Transformer	Speed adjustment	Phase control	Variable frequency drive	Variable frequency drive with sinusoidal filter
Installation	++	-	-	+	-	+	-	-	-
Noise characteristics	++	++	++	+	++	-	+	-	+
Power consumption	++	+	++	--	-	-	-	+	+
Service life	+	+	+	+	+	-	-	-	+

Noise characteristics: Motor with open-loop control

Key:

- ebm-papst EC control
- Variable frequency drive with sinusoidal filter
- Phase control without sinusoidal filter
- Phase control with sinusoidal filter
- Transformer

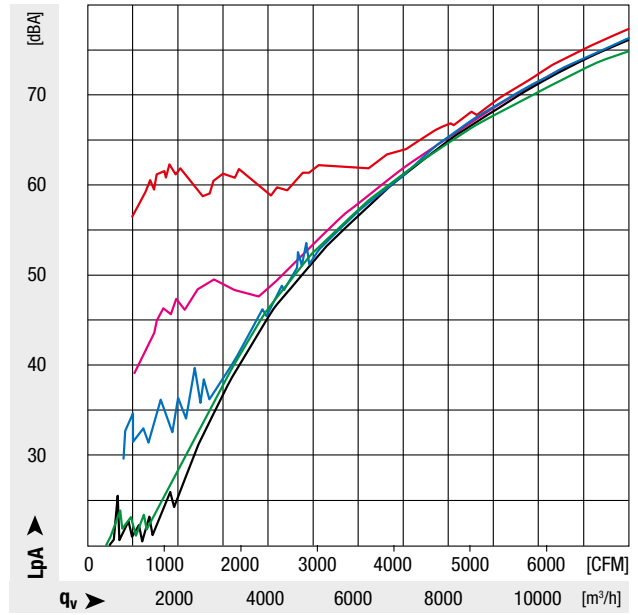

Power consumption: Motor with open-loop control

Key:

- ebm-papst EC control
- Variable frequency drive with sinusoidal filter
- Phase control without sinusoidal filter
- Phase control with sinusoidal filter
- Transformer

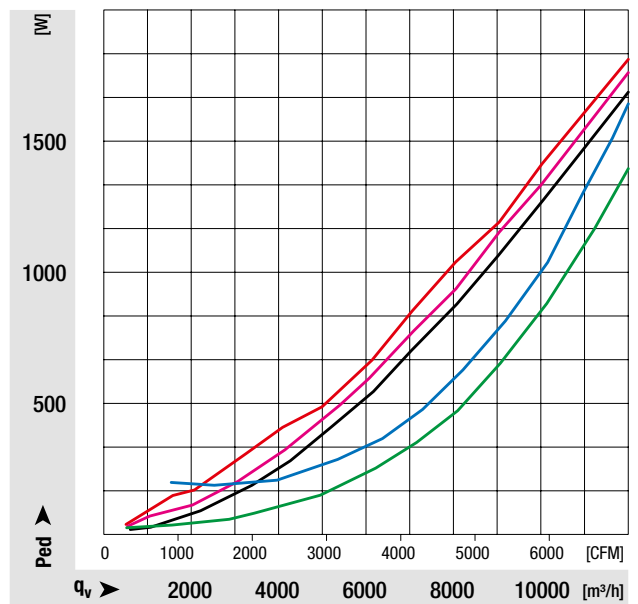

Open-loop control of EC motors

With EC motors, speed setting is performed by commutation electronics. By way of electronic switches, the motor currents are switched on and off on the basis of the rotor position.

Technical features

- PFC
- Integrated PID controller
- Control input 0-10 VDC/PWM
- Input for sensor 0-10 V or 4-20 mA
- Output 10 VDC
- Output for slave 0-10 V max. 5 mA
- Output 20 VDC ($\pm 20\%$) max. 50 mA
- RS485 MODBUS-RTU
- Motor current limitation
- Alarm relay
- Undervoltage detection
- Phase failure detection
- Thermal overload protection for electronics/motor
- Reverse polarity protection

Integrated commutation electronics

- Compact unit
- Simple installation
- Minimal assembly work
- Suitable for universal applications

Note: Motors with 12 - 72 VDC power supply require the use of an electrically isolated power supply.

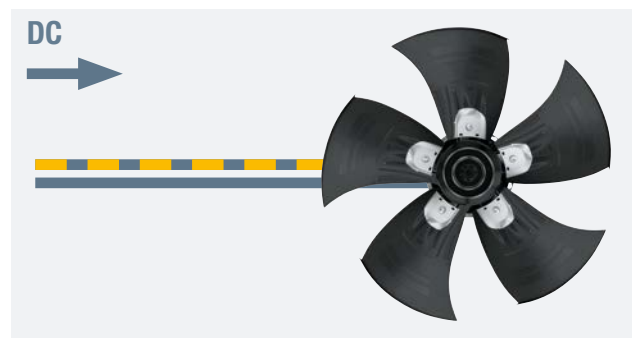
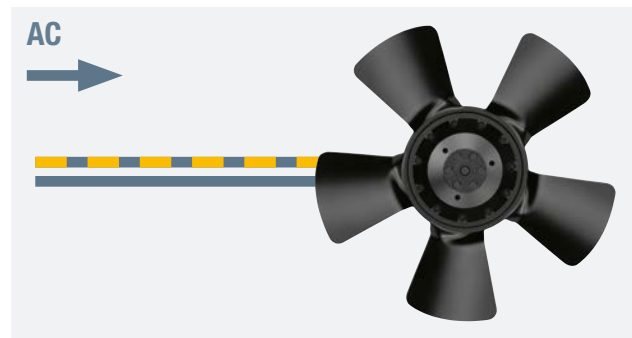

Block diagram of commutation electronics with AC supply

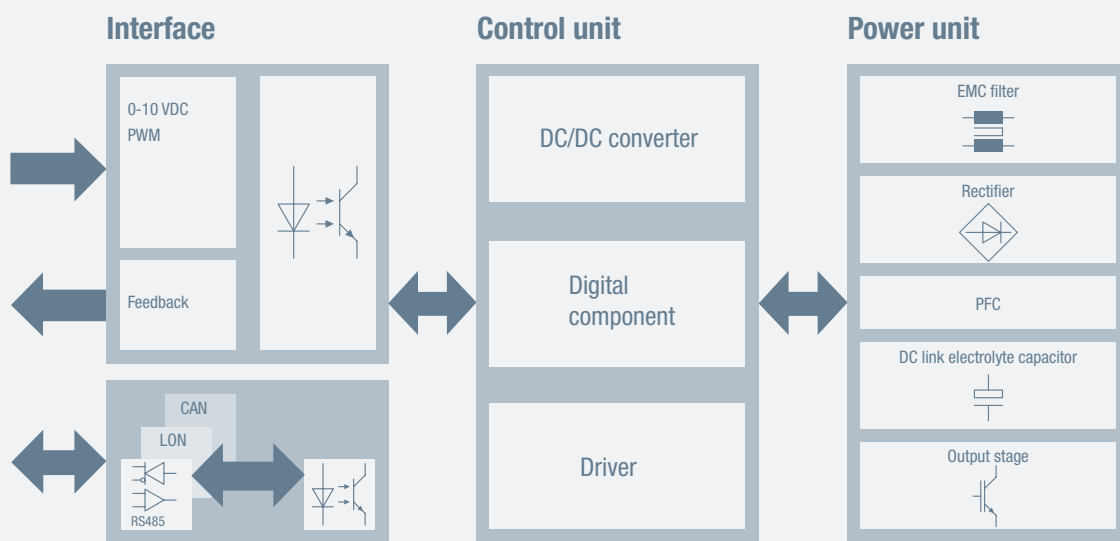

Block diagram of commutation electronics with DC supply

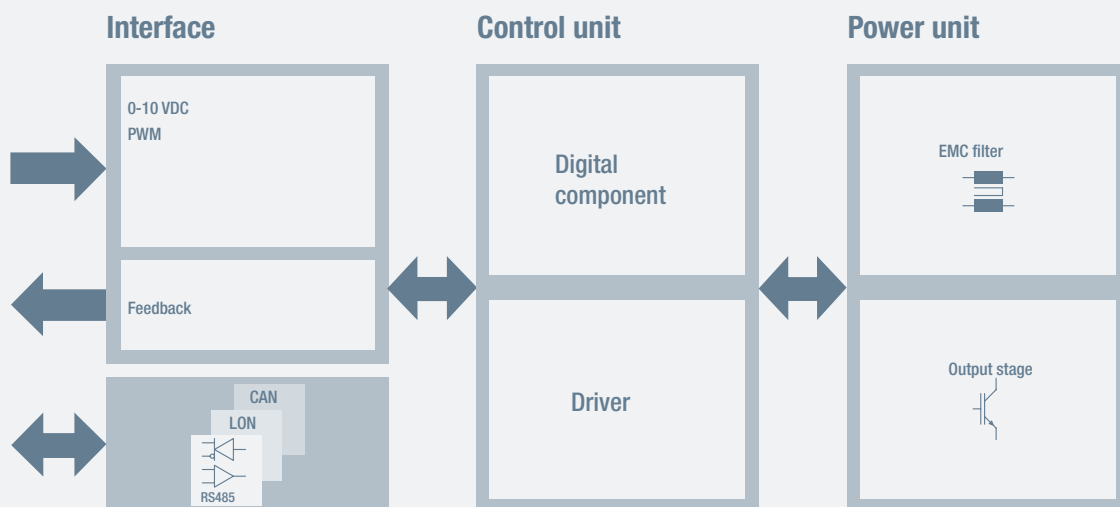

Open-loop control of EC motors

Interfaces

PWM

Digital input for open and closed-loop speed control.

The speed of the fan can be specified by way of the PWM (pulse width modulation) pulse width ratio. As can be seen from the following graph, the speed decreases with a shorter pulse duration.

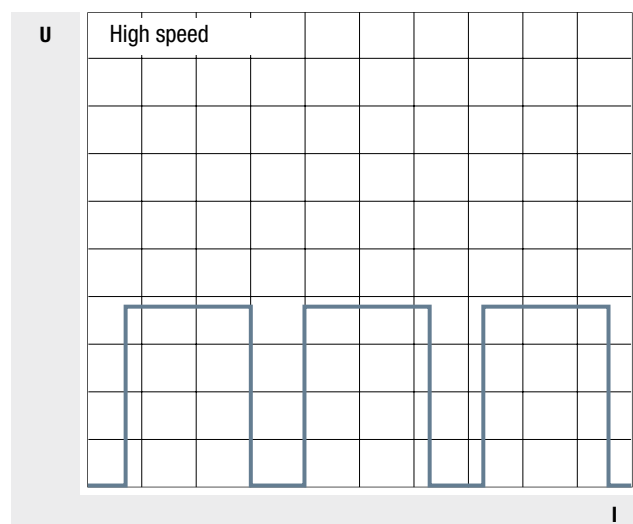
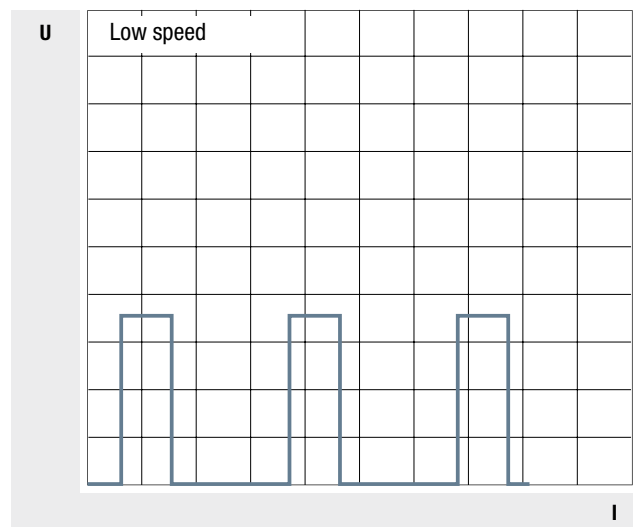
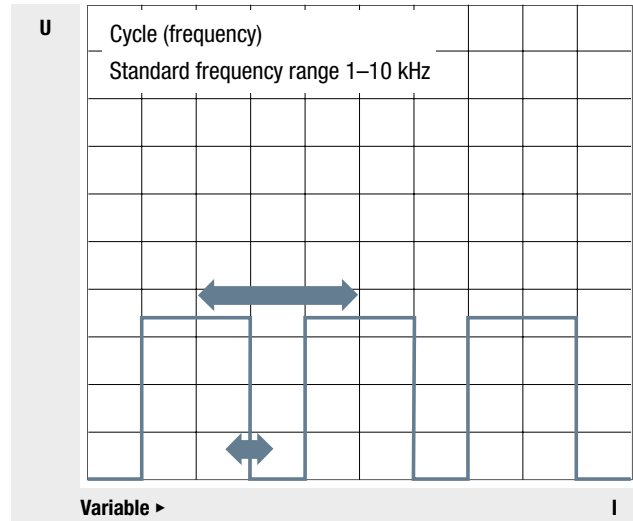

Linear interface

As can be seen from the graph, there is a linear relationship between the change in motor speed and the control voltage.

This control voltage may be specified by a temperature sensor, a pressure sensor or an external control device, for example.

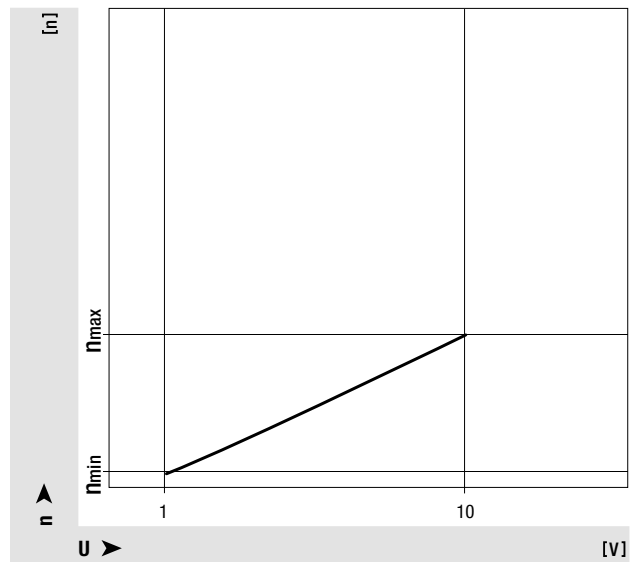

BUS

Standard: MOD-BUS

Hardware: RS-485 basic (two-wire BUS)

Serial information can be sent from and to the motor electronics by way of pulse patterns.

An external MODBUS-compatible control unit is required for this purpose.

For example, the speed, control parameters and direction of rotation are specified via the BUS, and feedback on the actual speed, the error status and the current motor power is received via the same BUS.

Open-loop control of EC motors

As the integrated electronics permit infinitely variable control of the EC motors, the speed can always be adapted to suit requirements.

This significantly increases efficiency in part load operation.

Typical features of ebm-papst commutation electronics:

- Inputs for analog and digital signals
- Open-loop control, closed-loop control and monitoring of the motor
- Integrated EMC filter
- Speed setting via a linear set value (0–10 VDC) or a pulse-width modulated signal
- Quiet running over the entire speed range
- Low additional costs for extra functions (open-loop/closed-loop control)
- BUS interface

Speed monitoring

The actual speed can be brought out as an electrical pulse via a signal wire.

As standard, one mechanical revolution corresponds to one pulse.

Optionally, several pulses can also be output per revolution.

Alarm relay

A relay contact (NC) is provided for status messages.

The designation NC stands for "normally closed". In the event of a fault, the relay contact opens and interrupts the signaling current, e.g. if the motor is blocked or the winding temperature is too high.



Integrated commutation electronics with switched-mode power supply

Power supply:

Safety extra-low voltage 24/48 VDC

Note: The switched-mode power supply is not included in the scope of delivery. Please order as an accessory.

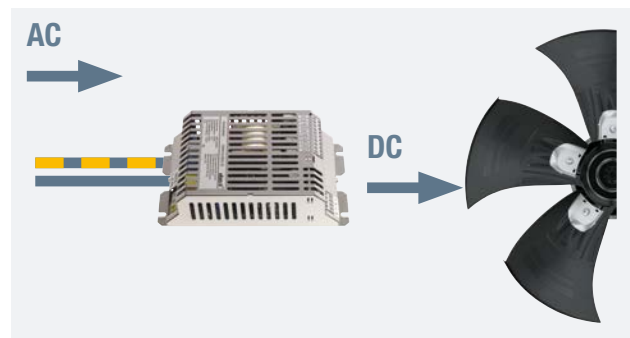

Open-loop control of EC motors

Fault types and reactions with EC motors

In the case of EC motors with DC supply, the electronics recognize certain faulty operating states that result in motor standstill, and then switch the motor back on again automatically.

By contrast, the electronics of EC motors with AC supply switch off the motor on detecting faulty operating states.

The motor re-starts automatically after the following types of fault:

- Power failure
- Failure of one phase
- Line undervoltage
- DC-link voltage too high or too low
- Blocked rotor

There is no automatic restart with the following types of fault.

A hardware or software reset is required:

- Motor temperature too high
- Heat sink temperature or ambient temperature of electronics too high
- Hall sensor fault

Hardware reset

A hardware reset can be triggered by switching off the fan and switching it back on again after one minute.

Software reset

A software reset can be started via ModBUS and EC-Control, a hand-held operating device or PDA with fan control software.

Currents

Leakage current

Leakage current is a current flowing in an unwanted conductive path under normal operating conditions (IEV 195-05-15). It is often caused by filter capacitors connected to the protective earth.

Leakage current is a general term. In standards, a distinction is made between the following depending on the conductive path:

- Protective earth current if the current flows via the protective earth and
- Touch current if the current flows externally through the body of a human or an animal.

Currents caused by faulty insulation (e.g. inadequate insulation resistance) or faulty devices are referred to as fault currents. These are not the same as leakage currents.

Start-up current

This describes the current that flows immediately after switching on an electric load (Power-On). The start-up current is often many times higher than the nominal current. The components of an electronic device therefore have to be dimensioned for this current. As the high start-up current only occurs for a brief period, the fuses of the electric load must not be tripped on switch-on (observe time lag class). The start-up current can easily be limited by way of an NTC thermistor or a fixed resistor for example.

Starting current

The starting current is the current that flows during the fan acceleration phase. This can be limited by way of a corresponding ramp-up curve, that can be parameterized in the software. During the ramp-up phase the current limitation can take effect and restrict the maximum current to the set limit value. This is not detrimental to the fan or its operation.

Open-loop control of AC motors

Speed setting permits the optimization of power consumption and flow noise to suit requirements.

When selecting a voltage regulator, it should be remembered that the nominal current in the part load range may be up to 20% higher than the specified maximum full load current (depending on the control device).

Series resistor

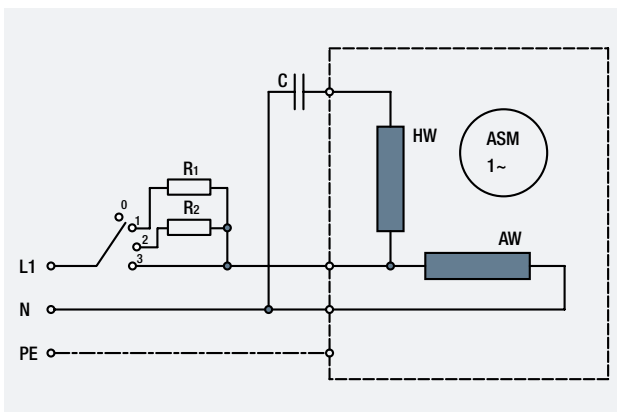

- Fixed speed levels
- Speed setting by changing the motor voltage
- Low-cost
- Low power levels

Note: Optionally available capacitors and chokes reduce the power loss.

Transformer

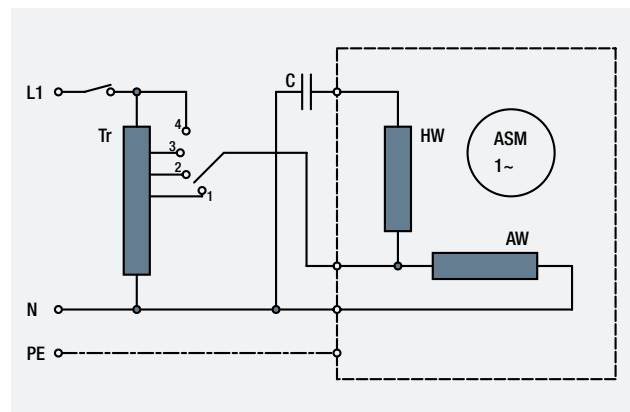

- Fixed speed levels
- Speed setting by changing the motor voltage



Phase control

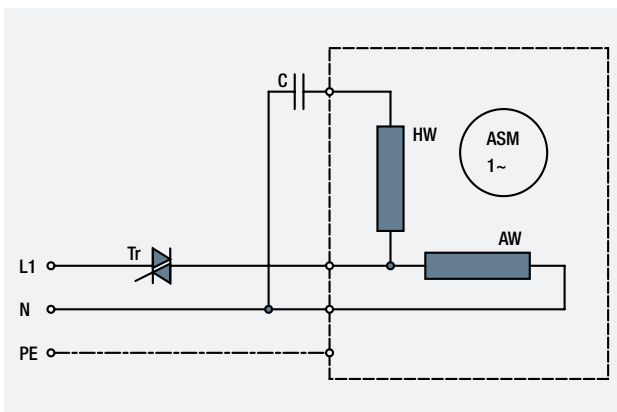

- Infinitely variable speed control
- Speed setting by changing the motor voltage
- Low-cost
- Noise characteristics and heat generation must be checked in the application

Variable frequency drive with sinusoidal filter

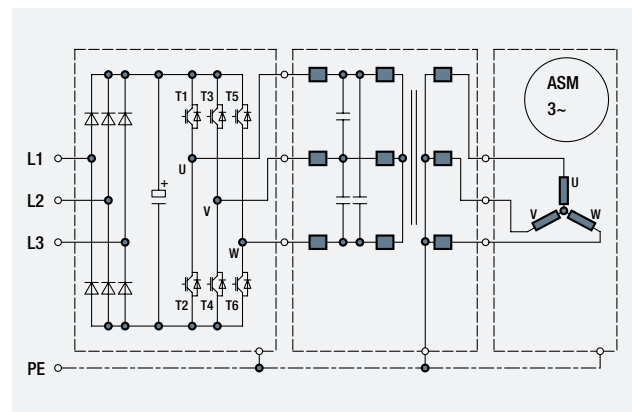

- Infinitely variable speed control
- Speed setting by changing the rotating field frequency
- High efficiency

Note: Use must be made of an all-pole sinusoidal filter (phase-phase and phase-ground) to prevent system disturbance.



Appendix

Factors influencing fan performance	88 91
General performance parameters	92 99
Performance measurement	100 103
Aerodynamics	104 105
Acoustics	106 109
Operating point	110 111
Efficiency figures	112 113
Electronics and EMC	114 121
Physical quantities, symbols, units	122 125
Index	126 127

Factors influencing fan performance

Speed

Influence of speed on fan curve

A change in speed influences the fan curve approximately as follows:

– Air flow q_v

$$q_v \sim n$$

– Static pressure increase p_{fs}

$$p_{fs} \sim n^2$$

– Power requirement P

$$P \sim n^3$$

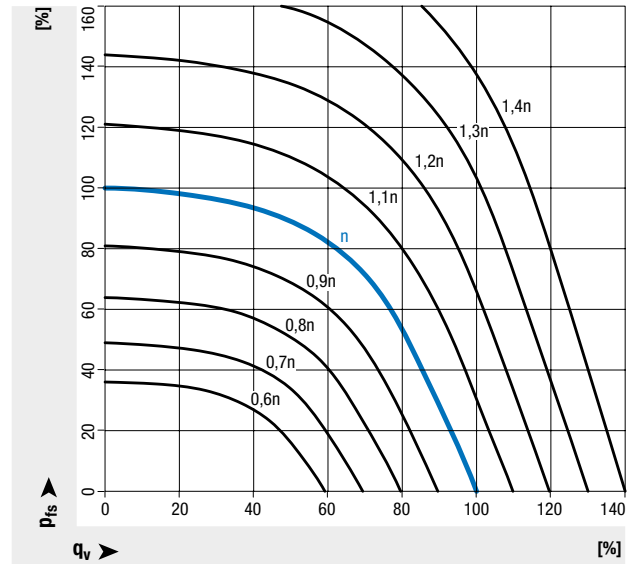

— Fan curve (at initial speed)

— Fan curve ($n = \text{Factor } x$)

Factors influencing fan performance

Impeller diameter

Influence of impeller diameter D (axial fans)

A change in the diameter of the impeller of an axial fan influences:

– The air flow q_V

$$q_V \sim D^3$$

– The static pressure increase p_{fs}

$$p_{fs} \sim D^2$$

– The power requirement P

$$P \sim D^5$$

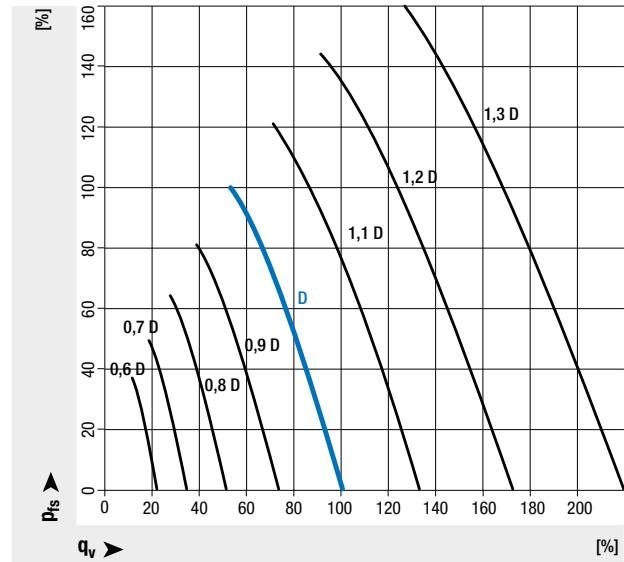

Influence of impeller diameter D and impeller width b (centrifugal fans)

A change in the diameter of the impeller of a centrifugal fan influences:

– The air flow q_V

$$q_V \sim D^3 \cdot b$$

– The static pressure increase p_{fs}

$$p_{fs} \sim D^2$$

– The power requirement P

$$P \sim D^4 \cdot b$$

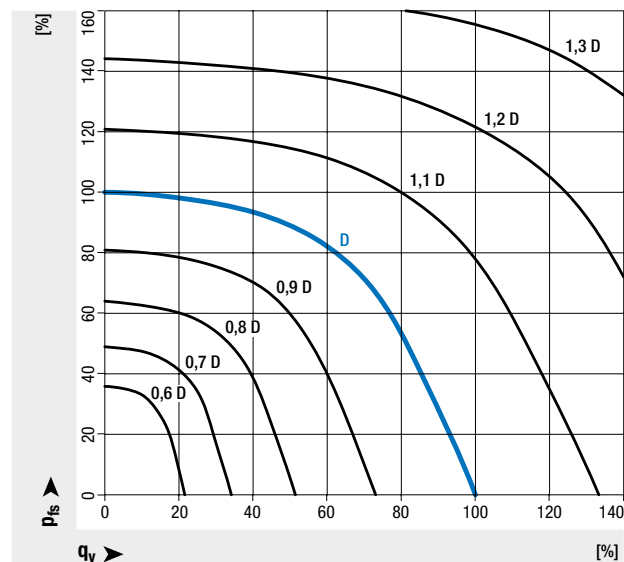

- Fan curve
(with initial diameter D and constant impeller width b)
- Fan curve
(with x-fold initial diameter D and constant impeller width b)

Factors influencing fan performance

Outlet width

Influence of outlet width b (centrifugal fans)

A change in the outlet width of a centrifugal fan has the following approximate influence:

– Air flow q_V

$$q_V \sim b$$

– Static pressure increase p_{fs}

$$p_{fs} = \text{constant}$$

– Power requirement P

$$P \sim b$$

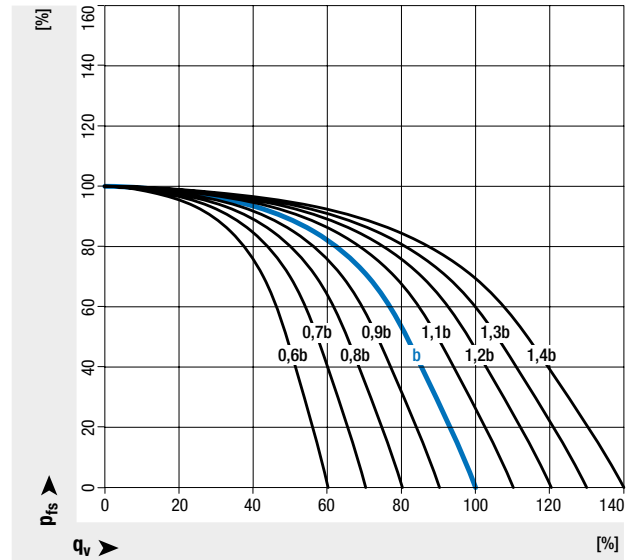

- Fan curve (with initial width b and constant diameter D of the impeller)
- Fan curve (with x -fold initial width b and constant diameter D of the impeller)

Factors influencing fan performance

Air density

In conformity with standard requirements, the air performance curves shown are referenced to an air density $\rho = 1.2 \text{ kg/m}^3$.

Influence of air density on fan curve

A change in air density changes the fan curve as follows:

- Air flow q_v
 $q_v = \text{constant}$
- Static pressure increase pfs
 $p_{fs} \sim \rho_0$
- Power requirement P
 $P \sim \rho_0$

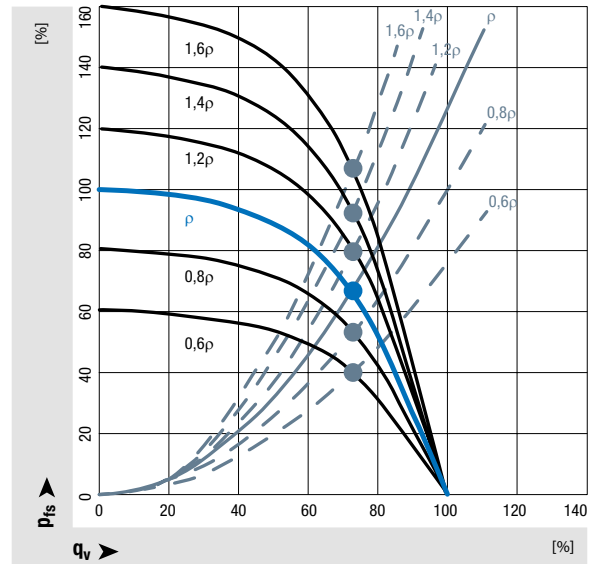

- Fan curve ($\rho = 1.2 \text{ kg/m}^3$)
- Fan curve ($\rho = x \text{ kg/m}^3$)
- System curve, parabolic resistance curve ($\rho = 1.2 \text{ kg/m}^3$)
- System curve, parabolic resistance curve ($\rho = x \text{ kg/m}^3$)

Environment & general conditions

General performance parameters

Any deviations from the technical data and conditions described here are given in the product-specific data sheet.

Service life

The service life of ebm-papst products depends on two main factors:

- The service life of the insulation system
- The service life of the bearing system

The service life of the insulation system is essentially governed by the voltage level, the temperature and the ambient conditions such as moisture and condensation. The service life of the bearing system is primarily governed by the thermal load on the bearings. For the majority of our products we use maintenance-free ball bearings that can be fitted in any installation position. In certain cases we also employ sliding bearings, as described in the product-specific documentation.

As a rough guide (depending on the boundary conditions), the ball bearings have a life expectancy L10 of approx. 40,000 hours of operation at an ambient temperature of 40°C. We will gladly provide you with a life expectancy calculation based on your specific usage conditions.

Standards & approvals

The products described in this catalog are developed and manufactured in accordance with the standards applying to the particular product and, if known, in accordance with the conditions of the particular area of application.

Information on standards is given in the product-specific data sheets.

Information on leakage current is given in the product-specific data sheets.

Measurement is performed in accordance with IEC 60990, Fig. 4.

Please contact us if you require a specific type of approval (VDE, UL, EAC, CCC, CSA, etc.) for your ebm-papst product. Most of our products can be supplied with the applicable approval. Information on existing approvals can be found in the product-specific data sheets.



Product tests

Mechanical stresses

All ebm-papst products are subjected to comprehensive testing in conformity with the normative specifications and also incorporating the extensive experience of ebm-papst.

Vibration test

Vibration testing is performed as follows:

- Vibration testing, operating, as per DIN IEC 68 Part 2-6
- Vibration testing, not operating, as per DIN IEC 68 Part 2-6

Shock load

Shock load testing is performed as follows:

- Shock load as per DIN IEC 68 Part 2-27

Chemical/physical stresses

Please consult your ebm-papst contact for any questions regarding chemical and physical stresses.

Flammability classes

Compliance with fire safety standards is often a prerequisite for the use of plastics in electrical engineering applications. The content of the Underwriters Laboratories specification UL 94 was incorporated into IEC/DIN EN 60695-11-10 and -20, as well as CSA C 22.2 in Canada. The flammability class ratings for the tested specimen thickness are 5V, V-0, V-1, V-2 (vertical burning test) and HB (horizontal burning test) (Fig. 1, 2, 3).

Materials

We make use of various materials for our fans. It is important to select the right materials for the application concerned. Information on materials can be found in the product data sheet.

Please get in touch with us. We would be pleased to help you select your fan.

Balancing grade

Balancing grade testing is performed as follows:

- Residual unbalance as per DIN ISO 1940
- Standard balancing grade G 6.3

The impeller-motor unit is dynamically balanced on two planes.

Should your particular application require a higher grade, please contact us and specify the details in the order.

Environment & general conditions

It is not uncommon for our fans to be operated under extreme conditions:

In industrial environments with corrosive media, in coastal regions with salt in the air or in very humid climatic zones.

We can supply various solutions to cope with the humid conditions encountered in tropical and sub-tropical countries.

Environmental classes

H0 (dry) No water action, no condensation	
Max. relative humidity	≤ 95%
Corrosion requirements	no
Application example	Condensing technology

H1 (moist) Water action through condensation	
Max. relative humidity	100%
Corrosion requirements	yes
Application example	Refrigerated display case in a supermarket

H2 (wet) Direct water action from outside through rain, snow or ice formation	
Max. relative humidity	100%
Corrosion requirements	yes
Application example	Outdoor condenser without rain protection

Installation position and condensation drainage hole

Information on installation position and condensation drainage hole is given in the product-specific data sheets.

Corrosion protection

Cathodic dip painting (CDP):

Characteristic features

- Even, full-area coating
- No drop formation
- Very good chemical and mechanical resistance
- Good overcoatability

Applications

- Outdoor areas
- Ventilation, refrigeration and air conditioning
- Automotive and railway engineering
- Outdoor telecommunications stations

Electrostatic powder coating (EPC):

Characteristic features

- Ultra-thin film powder
- Even coating
- No drop formation
- Very good chemical and mechanical resistance
- Evaporator system for wastewater-free operation
- Limited overcoatability

Applications

- Indoor and outdoor areas
- Industry
- Machinery
- General ventilation and air conditioning purposes
- Power engineering
- Switch cabinet and cooling systems
- Computer industry
- Control engineering

Winding impregnation

The drive is the heart of the fan and the electronics its brain. These highly sensitive "internal organs" require particularly good protection. One example of this is winding impregnation, which provides not only mechanical fixing and enhancement of the electrical insulation, but also protection against moisture.

Trickle impregnation

Standard for AC motors

On modern rotary table or linear machines, high-grade polyester resin of insulation class "H" is applied to the windings and then hardened.

Baking

Primarily for EC motors

Phase separation is created by the arrangement of the windings or winding phases (single-pole winding).

Vacuum impregnation

In this process, the entire stator is submerged in resin using vacuum. The aim is to achieve impregnation of the areas not directly forming part of the winding. This also seals small gaps and capillary pores which trickling cannot reach.

Full encapsulation

To obtain maximum protection of the winding against water and moisture, it is possible to fully encapsulate the winding. Either a casting or a pressing process is used for this purpose. This method is available for specific customer requirements and special applications.

Environment & general conditions

Degree of protection

The degree of protection defines the extent to which an electrical device is protected against the ingress of solid bodies such as fingers, dust etc. (first digit) and liquids (second digit). The degree of protection provides no indication of resistance to solvents and corrosion.

The degree of protection is given in the product-specific data sheets.

1st digit		2nd digit	Protection against liquids									
Protection against contact	Protection against solid bodies		No protection	Protection against vertical dripping water (condensation)	Protection against dripping water with the housing inclined by up to 15°	Protection against sprayed water from all directions including inclination up to 60° from the vertical	Protection against splashed water from all directions	Protection against water jet from all directions	Protection against heavy water jet from all directions	Protection against the ingress of water on immersion	Protection against the ingress of water on submersion	
			IP 0	IP 1	IP 2	IP 3	IP 4	IP 5	IP 6	IP 7	IP 8	
No protection	No protection against solid bodies	IP 0	IP 00									
Protection against contact with back of hand	Protection against solid bodies > 50 mm dia.	IP 1	IP 10	IP 11	IP 12							
Protection against contact with fingers	Protection against solid bodies > 12.5 mm dia.	IP 2	IP 20	IP 21	IP 22	IP 23						
Protection against contact with tools, wires etc. > 2.5 mm dia.	Protection against solid bodies > 2.5 mm	IP 3	IP 30	IP 31	IP 32	IP 33	IP 34					
Protection against contact with tools, wires etc. > 1 mm dia.	Protection against solid bodies > 1 mm	IP 4	IP 40	IP 41	IP 42	IP 43	IP 44					
Protection against contact with tools, wires etc. > 1 mm dia.	Protection against internal dust build-up	IP 5	IP 50				IP 54	IP 55	IP 56			
Protection against contact with tools, wires etc. > 1 mm dia.	Dust-tight (no ingress)	IP 6	IP 60					IP 65	IP 66	IP 67	IP 68	

Insulation class

The insulation class describes the permissible sustained temperature of the winding insulation.

The insulation class is given in the product-specific data sheets.

Insulation class	B = 130°C	F = 155°C	H = 180°C
Ambient temperature °C	40	40	40
Temperature rise °C	80	105	125
Reserve °C	10	10	15
Max. perm. temperature °C	130	155	180

Motor protection/thermal protection

The following protection methods are provided depending on the type of motor and area of application:

- Thermal overload protector, in-circuit or external
- PTC with electronic diagnostics
- Impedance protection
- Thermal overload protector with electronic diagnostics
- Current limitation via electronics

If use is made of an external thermal overload protector, a commercially available tripping unit must be connected by the customer for shut-off.

All single-phase AC fans are equipped with a thermal overload protector connected to the winding.

Motor protection conforming to the applicable standard must be fitted for products not provided with a built-in thermal overload protector and not protected against improper use.

Information on motor protection and thermal protection is given in the product-specific data sheets.

Environment & general conditions

Mode of operation



The mode of operation is given in the product-specific data sheets.

Modes of operation as per VDE 0530-1

S1	Continuous duty, constant load
S2	Short-term duty, constant load
S3	Intermittent duty, start-up does not influence temperature
S4	Intermittent duty, start-up influences temperature
S5	Intermittent duty, start-up & braking influence temperature
S6	Continuous duty with intermittent load
S7	Continuous duty with start-up & braking
S8	Continuous duty with load change

Protection class

The protection class is given in the product-specific data sheets.

Protection class	Symbol	Use with safety measure
I		With protective earth (equipment is connected to the protective earth system of the installation, e.g. electric motor)
II		Total insulation (equipment is provided with basic insulation and additional or reinforced insulation, e.g. lamps)
III		Extra-low voltage (connection to SELV and PELV electrical circuits only)

Explosion protection

Examples of ATEX markings, directive 2014/34/EU											
For gases		II	2G	E	Ex	ib			IIC		T4
For dust		II	2D		Ex	tD	A	21		IP65	T1 95°C
	As per 94/9/EC	Group: I: Mining II: All other environments	Class ①	In accordance with standards: E: EN50XXX (EU) A: NEC 505 (USA)	Certified explosion protection		Method: (DEC 6:241-1) A: Method A B: Method B	Zone ①		IP degree of protection	
						Ignition protection type:	EU marking:				Maximum surface temperature:
						GASES W: la/lb: Intrinsic safety q: Powder-filled m: Cast encapsulation o: Oil immersion e: Increased safety d: Flame-proof p: Pressurized nA: Non-sparking NC: Enclosed break NR: Restricted breathing NZ: Simple pressurization	Type of GAS I: Methane IIA: Propane IIB: Ethylene IIC: Hydrogen				GASES Marking (EU): T1: 450° T2: 300° T3: 200° T4: 135° T5: 100° T5: 85°
						DUST: pD: Pressurized tD: Protection by housing laD/lbD: Intrinsic safety mD: Cast encapsulation	USA marking: Class I: Mining II: All other environments III: Fibers				GASES Marking (USA): T1: 450° T2: 300° T2A: 280° T2B: 265° T2C: 230° T2D: 215° T3: 200° T3A: 180° T3B: 165° T3C: 160° T4: 135° T4C: 130° T5: 100° T6: 85°

Device class ①	Atmosphere G = Gases D = Dust	Device for use in
Class 1 Very high protection for zones that are permanently or very likely to be hazardous (zones 0 and 20).	G D	Zone 0 Zone 20
Class 2 High protection for zones that are likely to be hazardous (zones 1 and 21).	G D	Zone 2 Zone 21
Class 3 Normal protection for zones that are not very likely to be hazardous (zones 2 and 22).	G D	Zone 2 Zone 22

In the markings, the parentheses (...) or [...] indicate the corresponding equipment

Electric motors are available with different ignition protection types. A motor with explosion protection must be certified together with the corresponding control unit.

Performance measurement

Measurements on ebm-papst products are taken under the following conditions:

- Axial and diagonal fans in airflow direction "V" in full nozzle without guard grill
- Backward-curved centrifugal fans free-running with inlet ring
- Forward-curved single and dual-inlet centrifugal fans with housing
- Backward-curved dual-inlet centrifugal fans with housing



All air performance measurements are conducted on intake-side chamber test rigs conforming to the requirements of ISO 5801. The fans under test are attached to the measuring chamber with free air intake and exhaust (installation category A) and operated at nominal voltage, with alternating current also at nominal frequency, without any additional attachments such as a guard grill.

Intake-side chamber test rigs as per ISO 5801 for fan air performance measurements

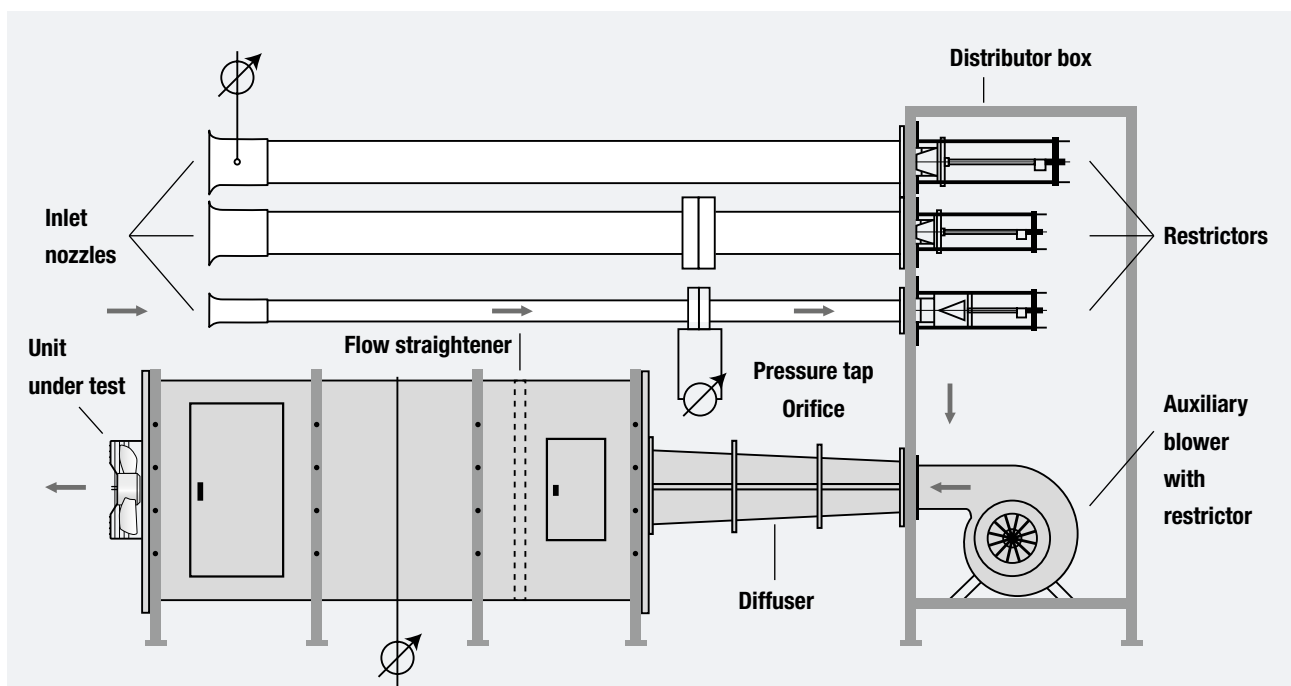

Air performance and sound measurement in combined test rig

- Structure consisting of 2 anechoic half chambers with reverberant floor and central wall
- Chamber satisfies accuracy class 1 as per ISO 3744 / 3745
- Sound power measurement class 2 as per DIN 45635-38 (microphone position in cuboid arrangement)
- Air performance measurement as per ISO 5801

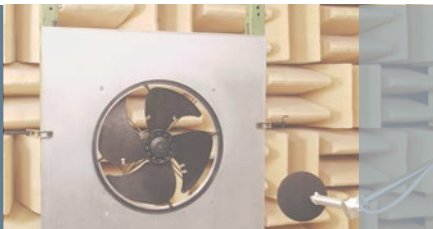

All sound measurements are taken in anechoic chambers with a reverberant floor. ebm-papst acoustic test chambers meet the requirements of accuracy class 1 as per DIN EN ISO 3745. For sound measurement, the fans being tested are positioned in a reverberant wall and operated at nominal voltage, with alternating current also at nominal frequency, without any additional attachments such as a guard grill.

A distinction is made between sound power and sound pressure. The sound pressure level L_p is always linked to the distance from the sound source; by contrast, the sound power level L_w does not depend on the distance from the sound source, i.e. it is the same for all distances from the sound source.

All sound values are determined as per ISO 13347, DIN 45635 and ISO 3744/3745 in accordance with accuracy class 2 and given in A-weighted form.

For measurement of the intake-side sound pressure level L_p the microphone is located on the intake side of the fan under test, generally 1 m away, on the fan axis.

For measurement of the intake-side sound power level L_w 10 microphones are distributed over an enveloping surface on the intake side of the fan under test (see graphic).

The measured sound power level can be roughly calculated from the sound pressure level by adding 7 dB.

Measurement set-up according to ISO 13347-3 and DIN 45635-38:

● 10 measuring points

$d \geq D$

$h = 1.5d \dots 4.5d$

Measurement area $S = 6d^2 + 7d(h + 1.5d)$

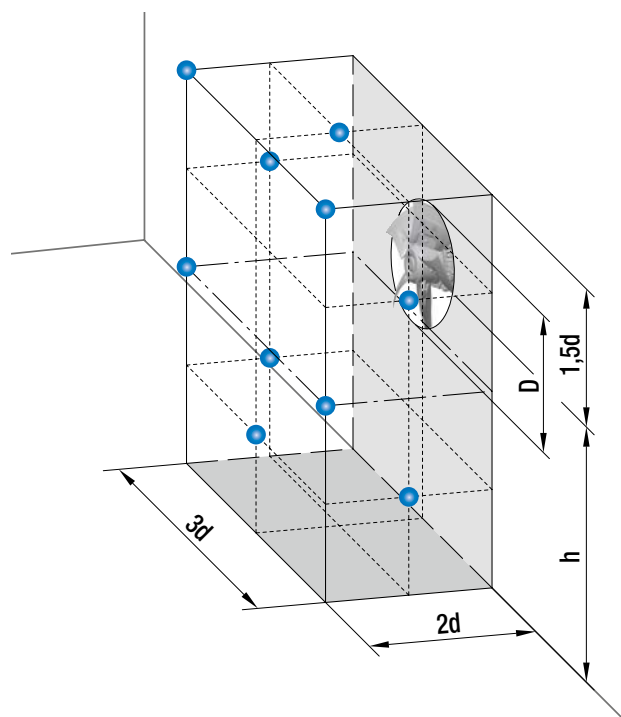





Performance measurement

Installation category

ISO 5801 describes the requirements for fan air performance measurements on a standard test stand.

The standard defines 4 different installation categories A, B, C and D.

Category	Intake side	Outlet side	
A	Free inlet	Free outlet	
B	Free inlet	With duct connected on outlet side	
C	With duct connected on intake side	Free outlet	
D	With duct connected on intake side	With duct connected on outlet side	

Accuracy classes

Accuracy classes as per DIN 24166 (ISO 13348)*

Drive power and efficiency

The following distinction is made with regard to drive power and efficiency measurements:

- P_e : Electric input power of a fan without variable speed control
- P_{ed} : Electric input power of a fan with external or internal variable speed control
- η_{es} : Static efficiency of a fan without variable speed control
- η_{esd} : Static efficiency of a fan with internal or variable speed control

Operational parameters	Limit deviation in class			
	0 (AN1)	1 (AN2)	2 (AN3)	3 (AN4)
Air flow q_V	±1%	±2.5%	±5%	±10%
Static pressure increase p_{fs}	±1%	±2.5%	±5%	±10%
Power consumption P_e	+2%	+3%	+8%	+16%
Static efficiency η_{es}	-1%	-2%	-5%	– (-12%)*
Sound power level L_{WA}	+3 dB (+2 dB)*	+3 dB	+4 dB	+6 dB

* Other designations and slightly different values in ISO 13348.

Aerodynamics

Air flow

Air flow

The air flow q_v of a fan is the volume of air that flows through the fan in a certain period of time as a function of temperature and the operating point. The air flow is pressure and temperature-dependent.

$$q_v = c \cdot A$$

$$q_v = \frac{V}{t} \quad \text{The SI unit of air flow in m}^3/\text{s}.$$

Conversion factors for air flow q_v	
$1 \frac{\text{m}^3}{\text{h}} = \frac{1}{3600} \frac{\text{m}^3}{\text{s}}$	$1 \frac{\text{m}^3}{\text{s}} = 3600 \frac{\text{m}^3}{\text{h}}$
$1 \text{ cfm} = 0.000472 \frac{\text{m}^3}{\text{s}}$	$1 \frac{\text{m}^3}{\text{s}} = 2118.85 \text{ cfm}$
$1 \text{ cfm} = 1.699011 \frac{\text{m}^3}{\text{h}}$	$1 \frac{\text{m}^3}{\text{h}} = 0.588578 \text{ cfm}$
$1 \frac{\text{l}}{\text{s}} = 0.001 \frac{\text{m}^3}{\text{s}}$	$1 \frac{\text{m}^3}{\text{s}} = 1000 \frac{\text{l}}{\text{s}}$

The continuity equation states that the air flow in a pipe is always constant.

The cross-section of a pipe and the flow velocity in a pipe are inversely proportional.

$$A_1 < A_2$$

$$q_{v1} = q_{v2}$$

$$c_1 \cdot A_1 = c_2 \cdot A_2$$

$$\frac{c_1}{c_2} = \frac{A_2}{A_1}$$

$$c_1 > c_2$$

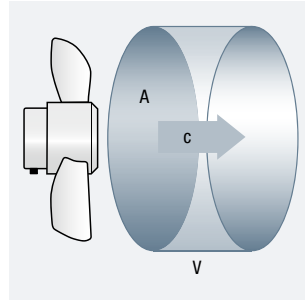

- q_v : Air flow
- V: Volume
- A: Flow cross-section
- c: Flow velocity
- t: Time

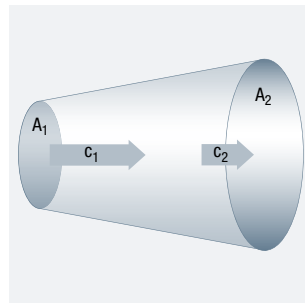

Pressure

Static and dynamic pressure

A distinction is made between static pressure (p_{fs}) and dynamic pressure (p_{fd}). The sum of the static and dynamic pressure is the total pressure (p_f).

$$p_f = p_{fs} + p_{fd}$$

Static pressure acts equally in all directions.

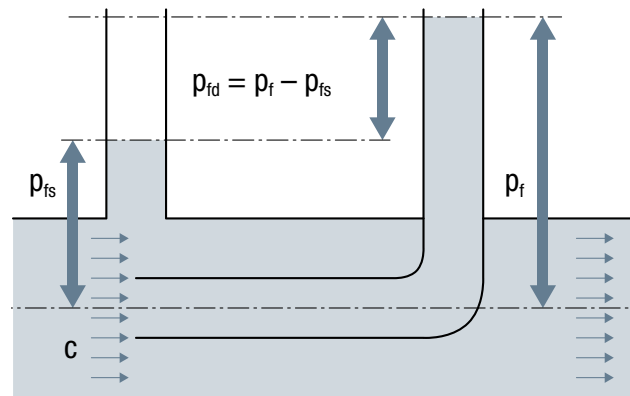

The dynamic pressure (p_{fd}) results from the flow velocity (c) of the flowing medium. The dynamic pressure is the greatest pressure increase before the midpoint of a flow obstruction.

p_f : Total pressure

p_{fs} : Static pressure

p_{fd} : Dynamic pressure

c : Flow velocity

q_V : Air flow

A : Flow cross-section

ρ : Density of the medium

$$p_{fd} = \frac{1}{2} \cdot \rho \cdot c^2$$

$$c = \frac{q_V}{A}$$

Acoustics

Sound pressure and sound pressure level

Sound pressure is a deviation produced by the sound source and superimposed on the ambient pressure. It depends on the distance r at which the sound is picked up by the receiver (microphone or ear).

$$L_pA = 20 \cdot \log\left(\frac{p}{p_0}\right)$$

L_pA = Sound pressure level

p = Sound pressure

p_0 = Ambient pressure

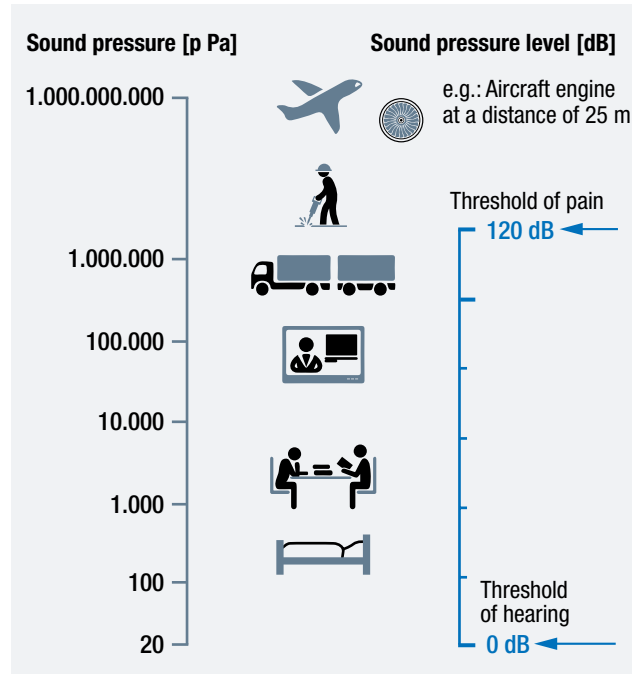

Distance laws

The sound pressure level decreases with increasing distance from the sound source. The adjacent graph shows the decrease in level referenced to an initial measurement at a distance of 1 m from the sound source under so-called far field conditions, i.e. the distance between the microphone and the fan must be extremely large in comparison with the fan diameter. The sound pressure level in the far field decreases by 6 dB each time the distance is doubled. Different relationships apply in the near field of the fan and the level may decrease to a far lesser extent.

The following example only applies to far field conditions and may vary considerably as a result of installation effects:

For an axial fan A3G300, a sound pressure level of 65 dB(A) was measured at a distance of 1 m. From the adjacent graph, this would yield a reduction of 26 dB at a distance of 20 m, i.e. a sound pressure level of 39 dB(A).

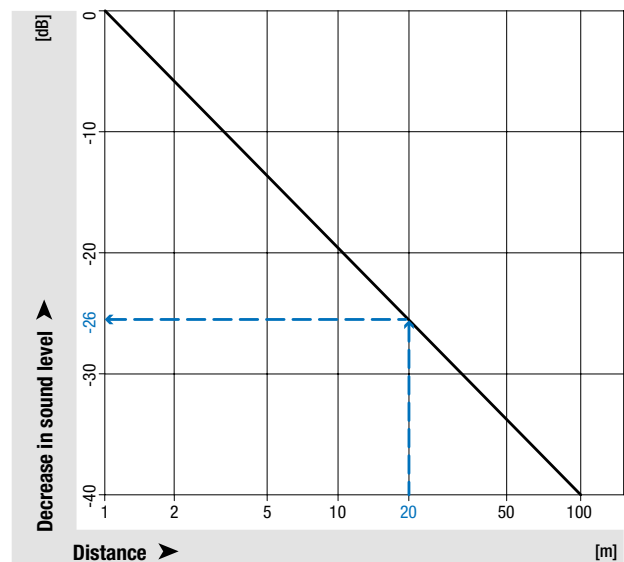

Sound power level

The sound power is the energy emitted by a sound source in a certain period of time. This energy is required to move the molecules of the surrounding medium, i.e. to generate the sound pressure. The sound power therefore does not depend on the distance r between the sound source and the receiver (e.g. microphone or ear).

$$L_W = 10 \cdot \log \left(\frac{P}{P_0} \right)$$

L_W : Sound power level

p : Sound pressure

p_0 : Ambient pressure

Addition of several sound sources with the same level (sound pressure level or sound power level)

The addition of 2 sound sources of the same volume produces a level increase of approx. 3 dB. The noise characteristics of several identical fans can be predicted on the basis of the sound values specified in the data sheet. This is shown in the adjacent graph.

Example: There are 8 axial fans on a condenser. According to the data sheet, the sound pressure level of one fan is 75 dB. The level increase determined from the graph is 9 dB. This means that a total level of 84 dB is to be expected for the installation.

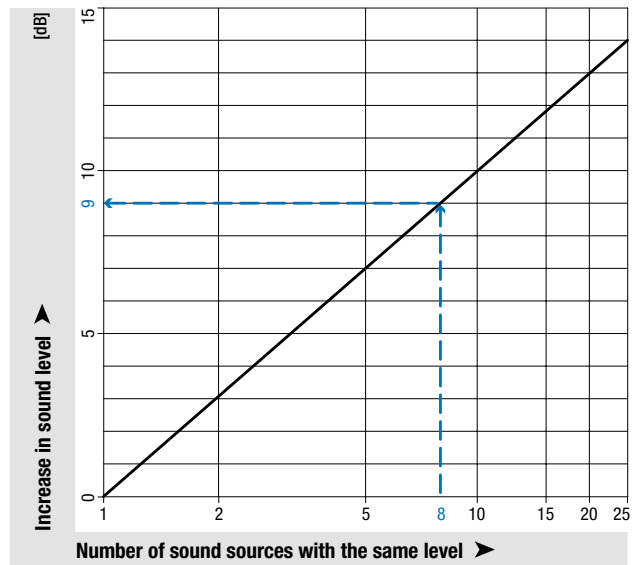

Addition of two sound sources with a different level (sound pressure level or sound power level)

The noise characteristics of two different fans can be predicted on the basis of the sound values specified in the data sheet. This is shown in the adjacent graph.

Example: An axial fan with a sound pressure level of 75 dB and an axial fan with 71 dB are in operation at the same time in a ventilation unit. The difference in level is thus 4 dB. An approx. 1.5 dB increase in level can now be read off the graph.

This means that a total level of 76.5 dB(A) is to be expected for the unit.

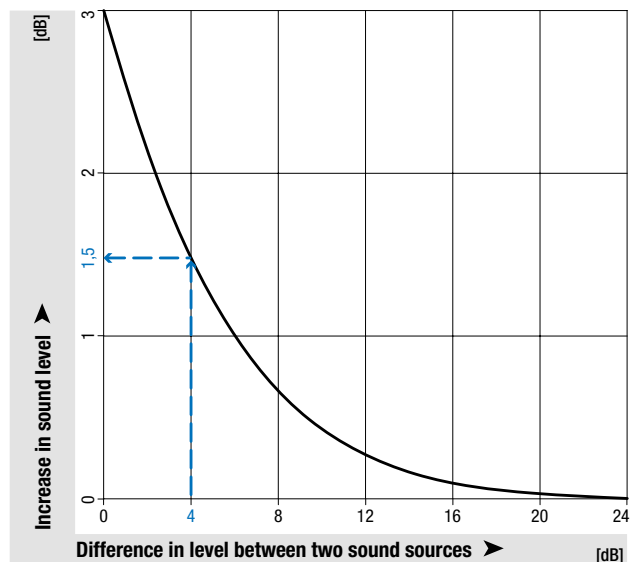

Acoustics

Influence of speed on noise level

The change in sound power or sound pressure level associated with a change in speed can be approximately determined on the basis of the adjacent graph and the following formula:

$$L_0 - L_1 = 50 \text{ dB} \cdot \log \frac{n_0}{n_1}$$

L_0 : Sound level before change in speed

L_1 : Sound level after change in speed

n_0 : Initial speed

n_1 : Changed speed

Example: There is one axial fan on a condenser.

According to the data sheet, the speed of this fan is 560 rpm with a sound power level of 66 dB. The fan is mostly operated at 420 rpm. As can be seen from the adjacent graph, the 5th factor of the 0.75 speed change thus decreases by approx. 6.3 dB

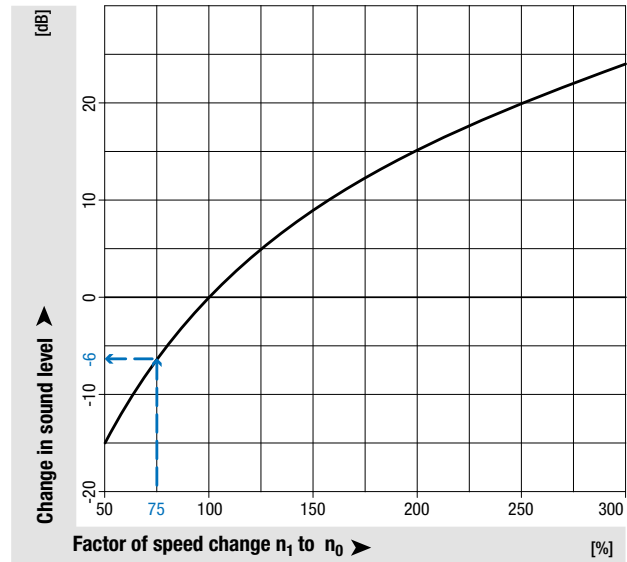

A-weighted sound power level

As the sensitivity of human hearing is highly dependent on frequency, defined correction values are employed to correct the measured sound pressure level at the individual frequencies, and the sound power level is then re-calculated from this. The standard method is to perform correction on the basis of the adjacent table (A-weighting). The newly weighted sound power levels are marked as such by adding the suffix "A" (e.g. 62 dBA).

Depending on the frequency, the real sound pressure level is approximated to the sensitivity of the human ear by way of specific correction values.

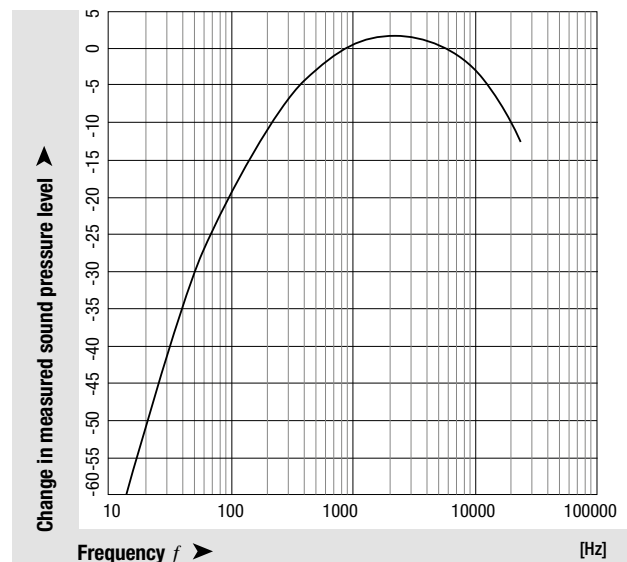

Correction values for A-weighting of sound pressure level as a function of frequency.

Sound pressure and sound power level in rooms

In rooms, the free sound field and the diffuse sound field are superimposed. Close to the sound source, direct sound dominates – and the acoustic properties of the room are of no relevance.

Further away from the source, indirect (reflected) sound dominates – and the sound level is relatively independent of the location but can be reduced by increasing the sound absorption.

The indirect sound pressure level can be calculated as follows:

$$L_p = L_W + 10 \cdot \log \left[\frac{Q}{4 \cdot \pi \cdot r^2} + \frac{4 \cdot RT}{0.163 \cdot V} \right]$$

Rooms	Reverberation time RT
Concert hall	1.5 to 3.0
Lecture theater	0.9 to 1.2
Restaurant, canteen, recreation room	0.6 to 1.0
Office	0.6 to 1.0
Classroom	0.5 to 0.7
Open-plan office	0.5 to 0.6
Film and sound control room	0.3 to 0.5

Directivity factor Q

Center of room: Q = 1

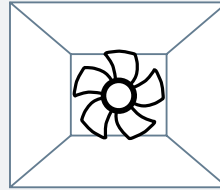

Center of wall: Q = 8

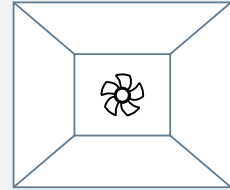

Edge of room: Q = 4

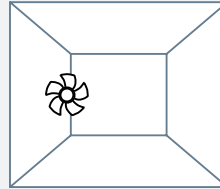

Corner of room: Q = 8

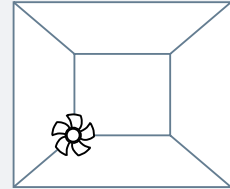

L_p : Sound pressure level in the room

L_W : Sound power of the sound source

r : Distance between source and receiver

V : Volume of the room in m^3

RT: Reverberation time

Q: Directivity factor

Operating point

Operating point

The performance curve of a fan represents the mutual relationship between air flow and pressure increase. The profile of the fan curve depends on the type of fan.

The operating point of a fan installed in a system is the point of intersection of the fan curve and the system curve. At this operating point, the pressure increase of the fan provides compensation for the pressure loss of the device. The actual air flow of the fan/system combination is thus obtained. The product of air flow and static pressure increase at the operating point yields the corresponding static air performance $P_{u(s)}$ of the fan.

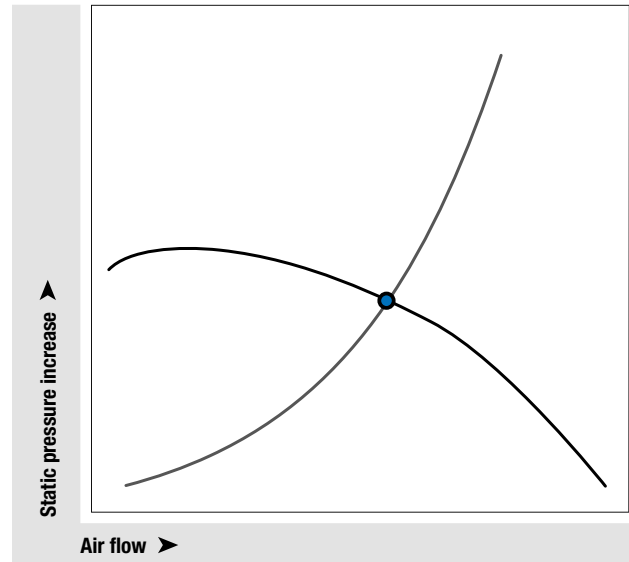

- Fan curve
- System curve (parabolic resistance curve)
- Operating point

Performance

The product of air flow and pressure increase corresponds to the aerodynamic output, i.e. the air performance of the fan.

$$P_u = p_f \cdot q_V = (p_{fs} + p_{fd}) \cdot q_V$$

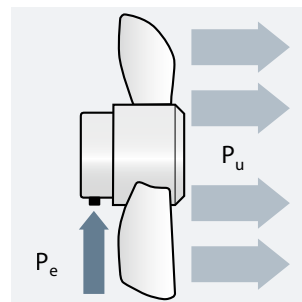

- q_V : Air flow
- p_f : Total pressure increase
- P_u : Fan air performance
- P_e : Power consumption (incl. control electronics)
- p_{fs} : Static pressure increase
- p_{fd} : Dynamic pressure increase

Efficiency

The efficiency of fans describes the degree to which the power input is converted into air performance.

$$\eta_e = \frac{q_V \cdot p_f}{P_i}$$

The system efficiency is the efficiency of the system as a whole and is made up of the individual efficiency levels of the components

Speed control - Motor electronics - Motor - Transmission - Impeller - Housing.

C_c : Speed control part load compensation factor

C_m Correction factor 0.9 when using individual components (mismatch factor)

η_b : Efficiency of the bearings when using an intermediate bearing

η_c : Efficiency of speed control/electronics

η_e : Efficiency of the fan (without speed control)

η_m : Efficiency of the motor

η_r : Efficiency of the impeller and, if applicable, the housing

η_T : Efficiency of the transmission (e.g. belt drive)

Example of a centrifugal fan with scroll housing, belt drive and external electronics as per ISO 12759

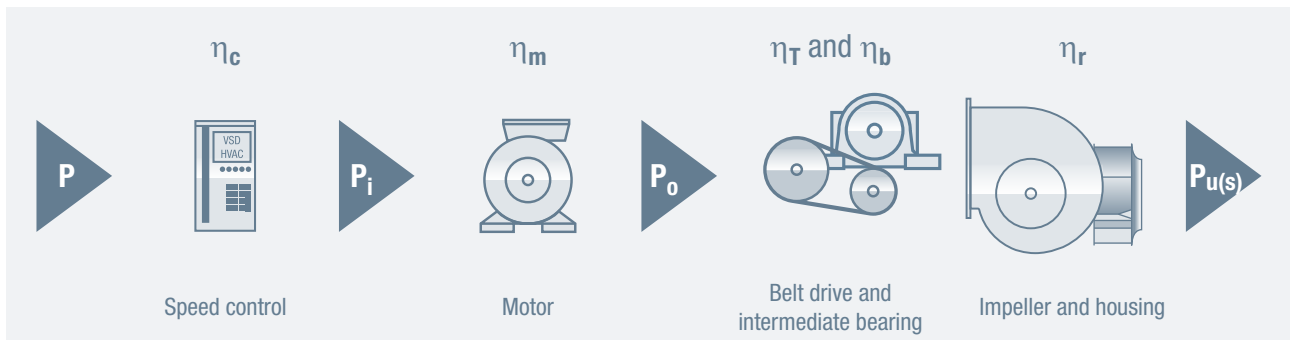

$$\eta_{e(s)d} = \eta_c \cdot \eta_m \cdot \eta_T \cdot \eta_b \cdot \eta_r \cdot C_m \cdot C_c$$

Example of an ebm-papst centrifugal fan

GreenTech EC motors from ebm-papst feature integrated speed control (VSD).

The losses associated with the drive configuration do not occur with direct drive fans, which means that η_c , η_T , η_b are all equal to 1 and C_m is also equal to 1, as a complete system is delivered rather than individual components.

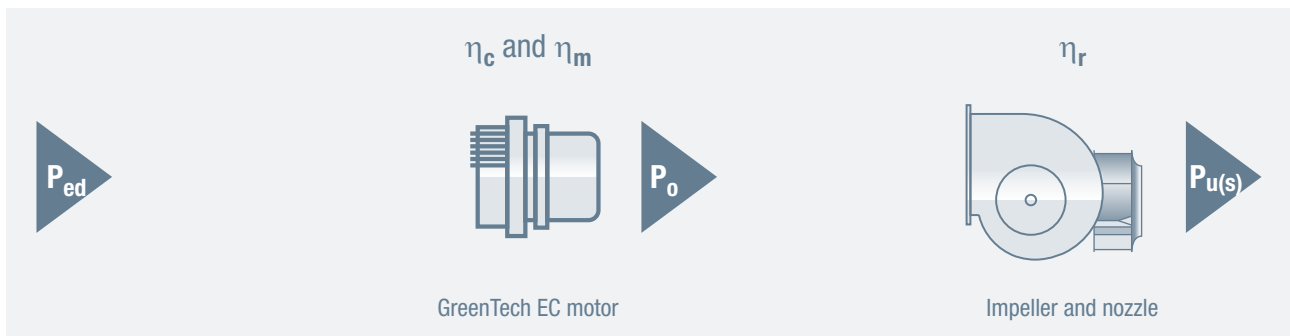

$$\eta_{e(s)d} = \eta_c \cdot \eta_m \cdot \eta_r \cdot C_m$$

Efficiency figures

Part load compensation factor

Speed control part load compensation factor C_c

$$125 \text{ W} < P_{ed} < 5000 \text{ W}: C_c = -0.03 \ln(P_{ed}/1000) + 1.088$$

$$P_{ed} \geq 5000 \text{ W}: C_c = 1.04$$

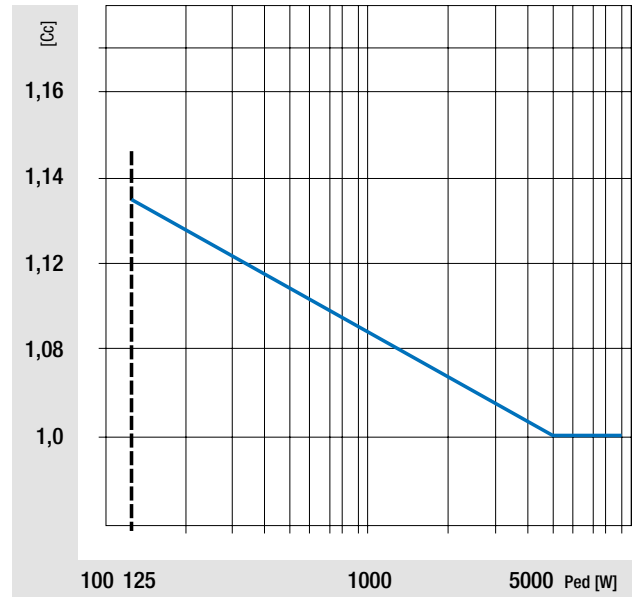

SFP Specific fan power

Specific fan power DIN EN 13779

The specific fan power is the ratio of power consumption to the air flow conveyed.

$$SFP = \frac{P_{ed}}{q_v} = \frac{p_f}{\eta_{ed}}$$

A low specific fan power can accordingly be attained with a low pressure loss and a fan system with a high efficiency level.

A combination of both is ideal!

SFP values are output in the FanScout software.

Category	SFP [Ws/m ³]
SFP-1	< 500
SFP-2	500 - 700
SFP-3	750 - 1250
SFP-4	1250 - 2000
SFP-5	2000 - 3000
SFP-6	3000 - 4500
SFP-7	> 4500

SFP value: Specific fan power

P_{ed} : Power consumption

q_v : Air flow

p_f : Pressure increase

η_e : System efficiency

η_{ed} : System efficiency taking into account demand-based speed adjustment (Cc factor)

Power factor

The "Power Factor" (PF) defines the relationship between effective power and apparent power. The effective power (P [W]) is the power transmitted to the output. The apparent power refers to the entire power input from the line ($S = U_{\text{rms}} \cdot I_{\text{rms}}$ [VA]).

The power factor (λ) is thus a measure of how effectively the electric energy is being used. It is calculated as follows:

(Power factor = $\lambda = \frac{|P|}{S}$). In theory a value of "1" would be desirable, but this can only be achieved with correspondingly complex electronics. The solution is to use an active PFC.

In the final analysis, the currently applicable standard has to be satisfied (in Europe EN 61000-3-2). For individual devices this can also be implemented in far less expensive form, employing an inductor in the DC circuit. With this version it is possible to obtain a power factor in the range 0.7-0.8.

For purely sinusoidal quantities, the power factor can be calculated as follows: (Power factor = $\frac{P}{S} = \cos \lambda$).

The angle λ describes the phase angle between current and voltage.

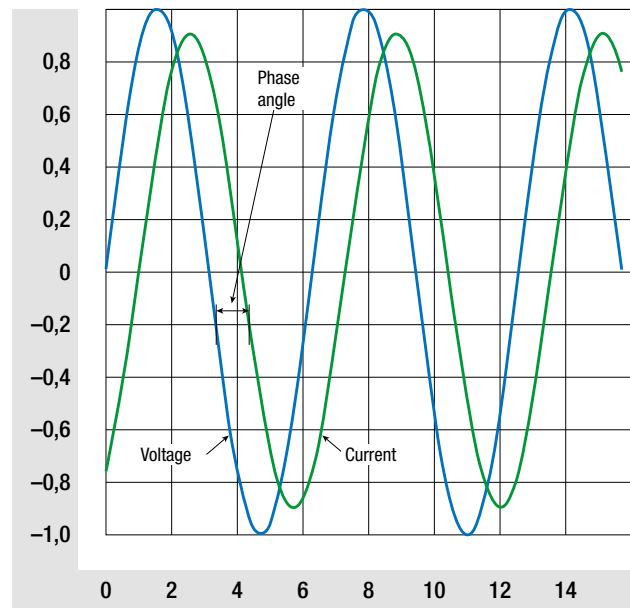

Power factor correction

As the name implies, the purpose of "Power Factor Correction" (PFC) is to correct the power factor. A value less than "1" means that, in addition to the required effective power, reactive power with a loss element is additionally being drawn from the line. This can have certain disadvantages.

Correction can be implemented either "passively" with a choke or "actively" with an additional control circuit.

A switched-mode power supply (as in our EC motors) only draws current from the line in short pulses. To obtain the same power, these must of course be somewhat higher than the resultant direct current. These peaks do however distort the line and could therefore cause interference in other devices. Such line (fundamental) distortions caused by harmonic components are referred to as "harmonics".

The two graphs show the same motor/fan impeller combination at the same operating point (the air performance setting was identical). The first graph shows operation of the system without PFC and the second graph operation with active PFC.

Active power factor correction takes the form of a circuit that regulates the current draw such that this lags the line voltage. Ideally, the regulated current will then be in phase with the line voltage $\varphi = 0^\circ$ and thus have a corrected power factor of $PF = \cos 0^\circ = 1$.

For non-sinusoidal current and voltage quantities, it is also important to keep the THD value as low as possible.

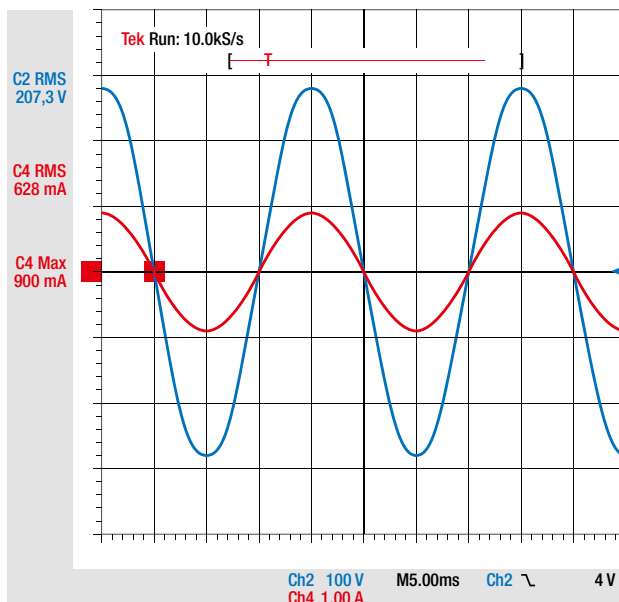
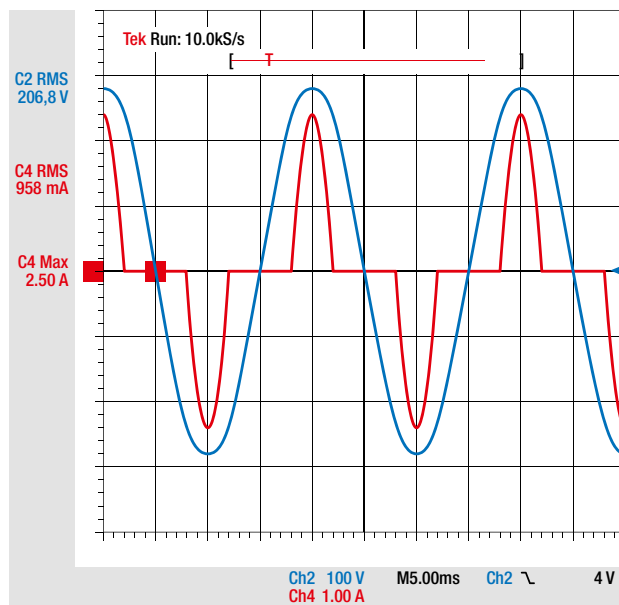

THD value

THD stands for "Total Harmonic Distortion". It is an indication of the magnitude of the non-linear distortion present.

The THD is defined as the relationship between the sum of the powers P_n of all harmonics and the power of the fundamental P_1 . For example, a square-wave signal with a frequency of 1 kHz contains a sinusoidal 1 kHz fundamental (this forms the basis for the power calculation for P_1) and harmonics with 3, 5, 7, 9-times etc. the fundamental frequency.

THD can be expressed in % or dB:

$$THD_{\%} = \frac{P_H}{P_1} \cdot 100$$

$$THD_{dB} = 10 \cdot \log_{10} \left(\frac{P_H}{P_1} \right)$$

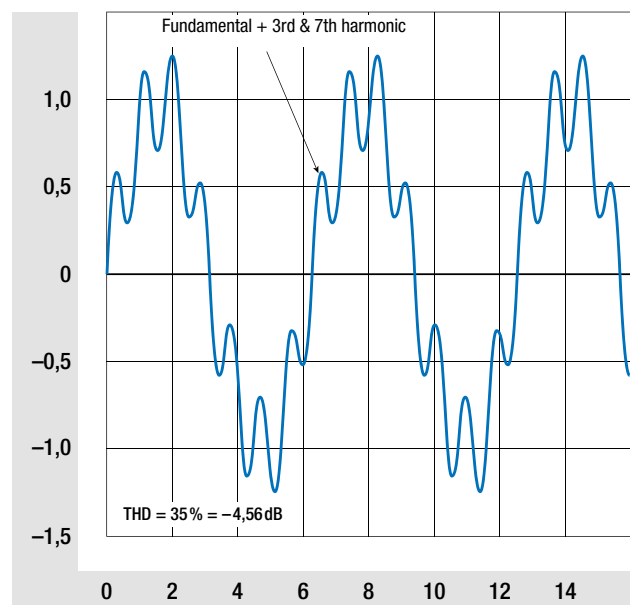
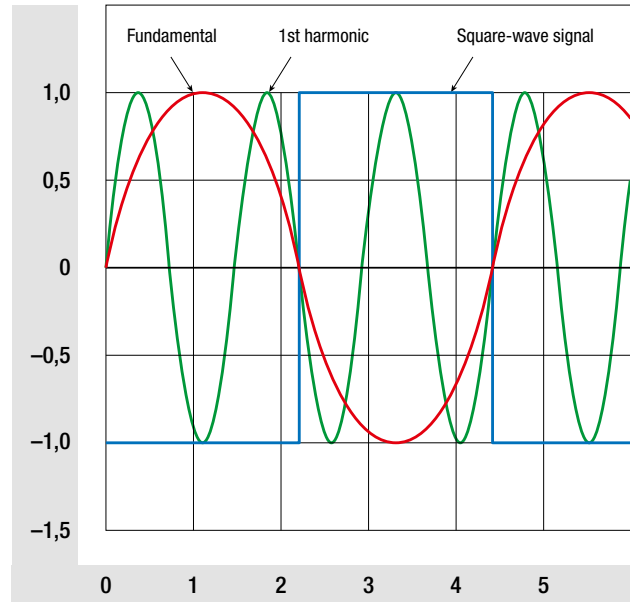

Electrical quantities

Calculation of electric power

Direct current (DC)

$$P = U \cdot I$$

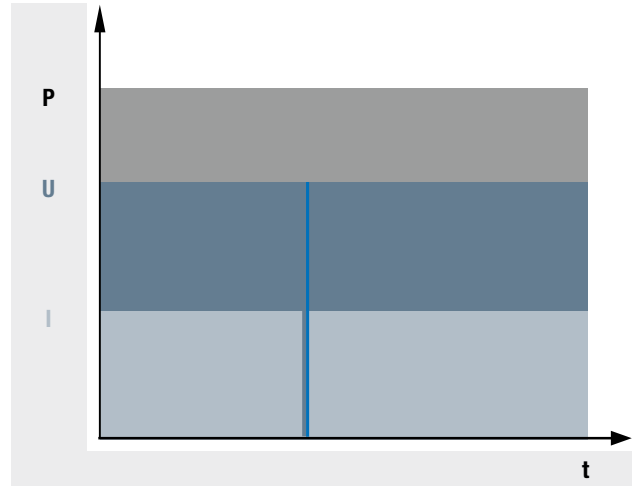

Alternating current (AC) with sinusoidal voltage/current waveform

Apparent power

$$S = U_{rms} \cdot I_{rms} \quad [\text{VA}]$$

Effective power

$$P = U_{rms} \cdot I_{rms} \cdot \cos \varphi \quad [\text{W}] = S \times \cos \varphi$$

Reactive power

$$Q = \sqrt{S^2 - P^2} \quad [\text{VAr}]$$

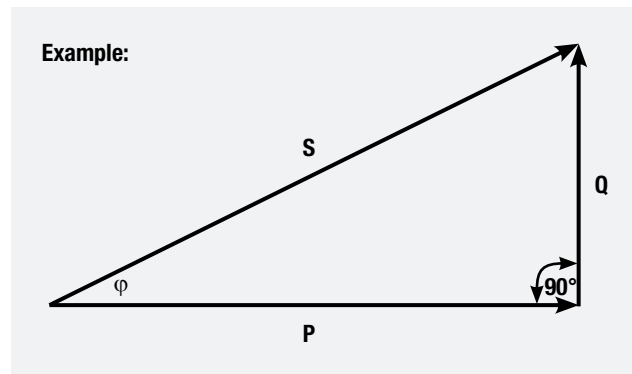

Alternating current (AC) with distorted, non-sinusoidal voltage/current waveform

Apparent power

$$S = U_{rms} \cdot I_{rms} = \frac{P}{\cos \varphi} \quad [\text{VA}]$$

Effective power

$$P = U_{rms} \cdot I_{rms} \cdot \cos \varphi \quad [\text{W}]$$

Reactive power

$$Q = \sqrt{S^2 - P^2} \quad [\text{VAr}]$$

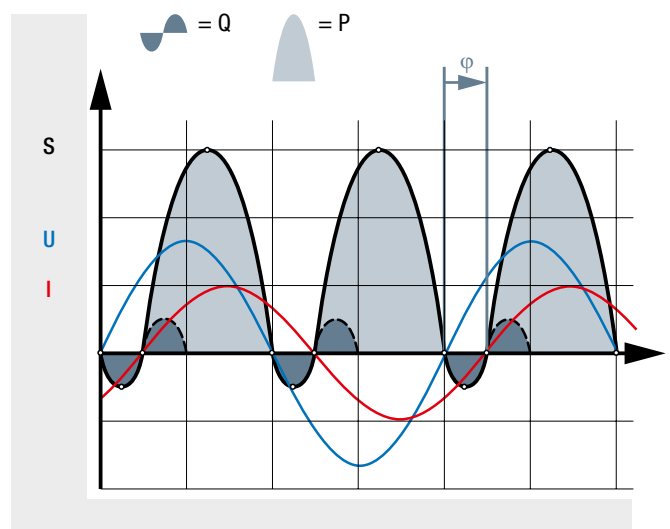

Electrical quantities

Synchronous speed of AC asynchronous motors

$$n_{sync} = \frac{2 \cdot 60}{p} \cdot f$$

p	f = 50 Hz	f = 60 Hz
2	3000 rpm	3600 rpm
4	1500 rpm	1800 rpm
6	1000 rpm	1200 rpm
8	750 rpm	900 rpm
12	500 rpm	600 rpm

p: Number of poles

f: Line frequency

Slip

$$s = n_{sync} - n_{idle}$$

Typical torque/speed curve of a 4-pole AC asynchronous motor at various frequencies.

A change in frequency alters the torque curve and the amount of slip between idle speed and synchronous speed

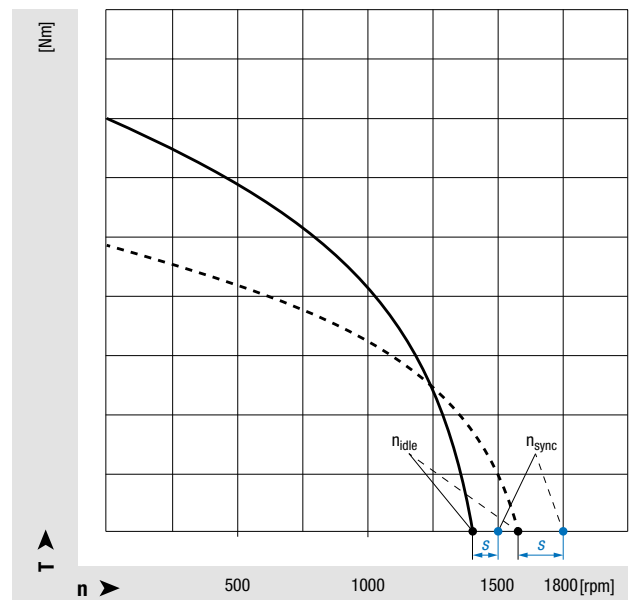

— f = 50 Hz

--- f = 60 Hz

n_{idle} : Idle speed

n_{sync} : Synchronous speed

Surge and burst

Further to the information in the section "EMC", the terms "surge" and "burst" will now be explained. These are defined in the EMC test standards.

– EN 61000-4-4:2013

Electrical fast transient/burst immunity test → low-energy

– EN 61000-4-5:2006

Surge immunity test → high-energy

ESD

The term "electrostatic discharge" ESD refers to a spark or breakdown resulting from a large potential difference. This potential difference usually occurs when the human body, for example, becomes charged with frictional electricity. When walking over a carpet, a human being may pick up a charge of approx. 30,000 V. If this enormous potential difference then comes into contact with an electrical component or device, it will be exposed to a brief, high voltage pulse that could result in damage to the device or component. The voltage pulse could however also cause a flammable gas to ignite.



Definition of nominal voltage

Since 2009, 230 V line voltage has been subject to a permissible deviation of $\pm 10\%$, which means that the tolerance band extends from 207 V to 253 V. In Europe the line frequency is 50 Hz.

Our devices are designed for these limits and thus permit trouble-free operation on 230 V line voltage with $\pm 10\%$ deviation.

EMC

EMC stands for "electromagnetic compatibility" and refers to the generally desirable situation where there is no mutual interference between technical devices as a result of unwanted electrical or electromagnetic influences.

Interference emission

Electromagnetic interference emission refers to the unwanted effect of an electrical or electronic device acting as a source of electromagnetic interference and thus causing interference in other devices. In the EU the permissible interference emission is regulated by the requirements of the EMC directive with reference to the corresponding standards. These standards contain the limit values for certain frequency ranges, equipment categories and environments. With regard to interference emission, a distinction is made between conducted interference emission and radiated interference emission. Interference emission is also referred to as "Electromagnetic Interference" (EMI).

Immunity to interference

Immunity to electromagnetic interference describes the desired resistance of a system under test, enabling it to operate up to a certain level or set value without being susceptible to interference from an external source of interference.

The magnitude of the disturbance chosen for EMC measurements is generally higher than that specified in the standard.

Immunity to interference is often also referred to as "Electromagnetic Susceptibility" (EMS) or, more accurately, "Electromagnetic Immunity".

Information on EMC standards can be found in the product-specific data sheets.

Compliance with EMC standards has to be assessed on the final product, as EMC properties may change under different installation conditions.

Standard voltages and networks

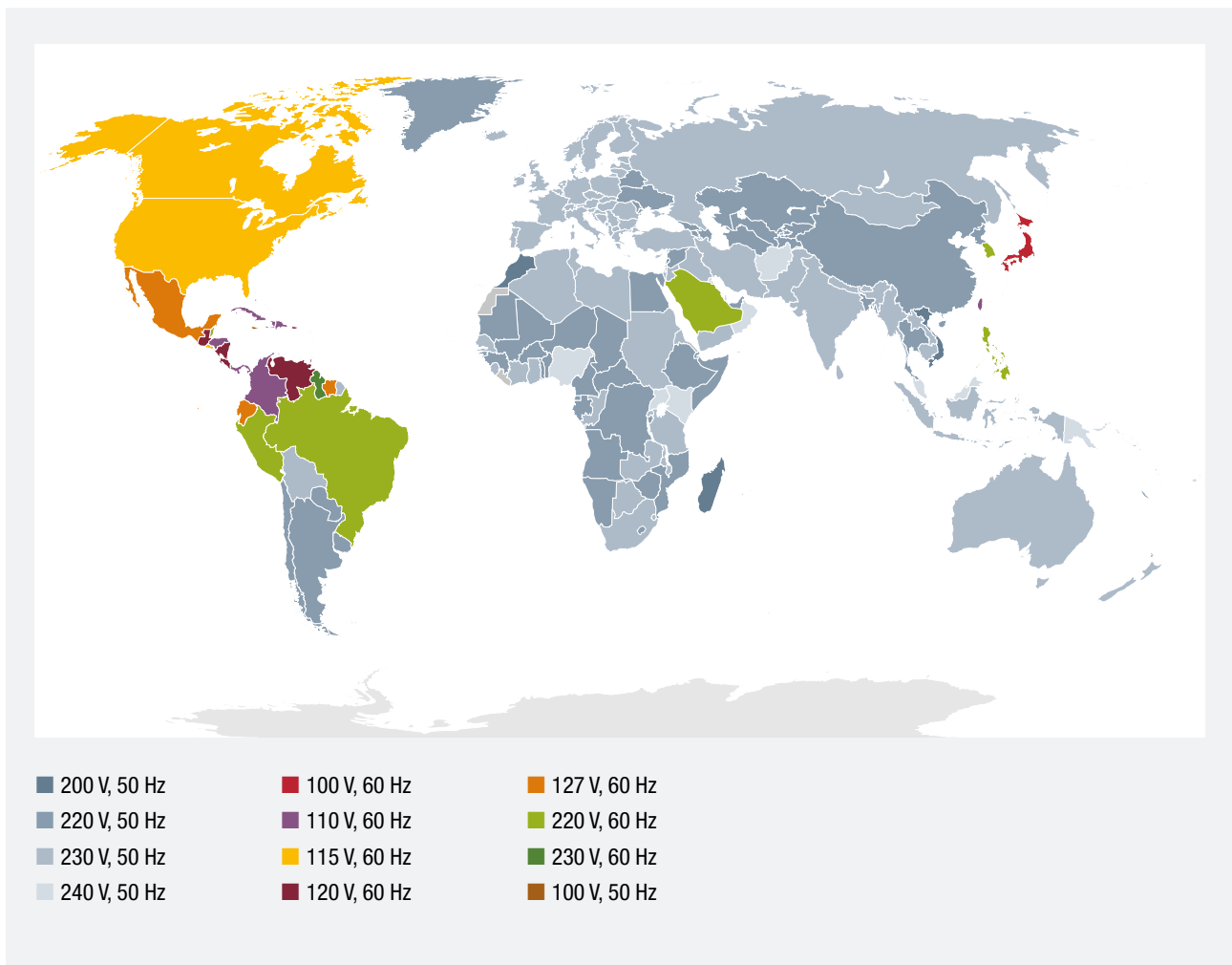

In accordance with IEC 60038, the line voltage is characterized in terms of the nominal voltage, the tolerance of the nominal voltage and the nominal frequency. In Europe, further voltage characteristics (frequency, magnitude, waveform and symmetry of the three-phase voltages) are specified in the standard EN 50160.

In some countries networks differ from region to region.

ebm-papst fans with 3-phase AC supply are intended for use in systems with a grounded neutral (TN/TT systems) or, in the US, for use in systems with a grounded phase conductor.

Physical quantities, symbols, units

Physical quantity	Symbol	Unit
Frequency	f	Hz
Speed	n	rpm
Mass	m	kg
Temperature	T	°C
Temperature changes (e.g. winding heat-up)	ΔT	K
Pulse width modulation	PWM	%
Density	ρ	kg/m ³
Fuse		mA, A
Leakage current	I_{lc}	mA
Nominal voltage	U_N	VDC, VAC
Nominal voltage range	U_N	VDC, VAC
Voltage	U	VDC, VAC
Voltage range	U	VDC, VAC
Motor power consumption	P_e, P_{ed}	W, kW
Motor output power	P_o	W, kW
Fan air power	P_u	W, kW
Fan static air power	P_{us}	W, kW
Current draw	I_N or I_1, I_2, I_3 (3-phase)	A
Capacitor voltage	U_c	V
Capacitor capacitance	C	μF
Efficiency of electronics	η_c	%
	$\cos \varphi$	No unit
Power factor	λ	No unit
Total harmonic distortion	THD(U) or THD(I)	%
Torque	M	Ncm, Nm
Starting torque	M_I	Ncm, Nm
Saddle torque	M_u	Ncm, Nm
Breakdown torque	M_b	Ncm, Nm
Motor efficiency	η_m	%
Fan impeller efficiency	η_r	%
Fan impeller static efficiency	η_{rs}	%
Overall efficiency	η_e, η_{ed}	%
Static overall efficiency	η_{es}	%
Sound pressure level	L_pA	dB(A)
Sound power level	L_WA	dB(A), bel
Sound power level, intake side	$L_WA(A^*, in)$	dB(A)
Sound power level, outlet side	$L_WA(A^*, out)$	dB(A)

Physical quantities, symbols, units

Physical quantity	Symbol	Unit
Sound pressure level, intake side	$L_p A^*(A, in)$	dB(A)
Sound pressure level, outlet side	$L_p A^*(A, out)$	dB(A)
Air flow	q_v	m ³ /h , l/s, cfm
Static pressure increase	p_{fs}	Pa, in H ₂ O
Static pressure increase converted to standard density	p_{fs12}	Pa, in H ₂ O
Total pressure increase	p_f	Pa
Dynamic pressure	p_{fd}	Pa
Medium exhaust speed	v_m	m/s
Specific fan power	SFP	kW/(m ³ /s)
Min. back pressure	$p_{fs, min}$	Pa
Max. back pressure	$p_{sf, max}$	Pa
Delivery head	H	m
Flow rate	q_v	m ³ /s, m ³ /h, l/s, l/h
Differential nozzle pressure	Δp	Pa
k-factor	k	

* "A" refers to the installation category and may accordingly also be "B"

Lengths

1 mm = 0.0394 in. (inch)	1 in. (inch) = 25.4 mm
1 m = 3.281 ft. (feet)	1 ft. (foot) = 0.3048 m
1 m = 1.094 yd. (yards)	1 yd. (yard) = 0.9144 m
1 km = 0.6214 mi. (miles, UK)	1 mi. (mile, UK) = 1.609 km

Areas

1 cm ² = 0.155 in. ² (square inch)	1 in. ² (square inch) = 6.452 cm ²
1 m ² = 10.76 ft. ² (square feet)	1 ft. ² (square foot) = 0.0929 m ²
1 m ² = 1.196 yd. ² (square yards)	1 yd. ² (square yard) = 0.8361 m ²
1 km ² = 0.386 mi. ² (square miles)	1 mi. ² (square mile) = 0.4047 ha

Volume

1 cm ³ = 0.061 in. ³ (cubic inch)	1 in. ³ (cubic inch) = 16.39 cm ³
1 dm ³ = 1 l (liter)	1 l (liter) = 1 dm ³
1 m ³ = 35.32 ft. ³ (cubic feet)	1 ft. ³ (cubic foot) = 28.32 dm ³ (1.728 in ³)
1 m ³ = 1.308 yd. ³ (cubic yards)	1 yd. ³ (cubic yard) = 0.7645 m ³
1 l = 1.76 pints (UK)	1 pint (UK) = 0.568 l
1 l = 0.2205 gal. gallon (UK)	1 gal. (gallon, UK) = 4.546 l
1 l = 0.2642 gal. gallon (US)	1 gal. (gallon, US) = 3.785 l

Mass

1 gr = 0.0353 oz. (ounce)	1 oz. (ounce) = 28.35 gr
1 kg = 2.205 lb. (pounds)	1 lb. (pound) = 0.4536 kg
1 kg = 0.00098 t	1 t = 1016 kg

Air flow

1 m ³ /s = 2119 cfm	1 cfm = 0.000472 m ³ /s
1 m ³ /h = 0.589 cfm	1 cfm = 1.699 m ³ /h
1 m ³ /s = 13210 gpm	1 gpm = 0.000758 m ³ /s

Pressure

1 N/m ² = 0.004 in. (inch) water column	1 in. (inch) water column = 249.1 N/m ²
1 Pa = 0.004 in. (inch) water column	1 in. (inch) water column = 249.1 N/m ²
1 mbar = 0.401 in. (inch) water column	1 in. (inch) water column = 2.491 mbar
1 kp/m ² = 0.0394 in. (inch) water column	1 in. (inch) water column = 25.4 kp/m ²
1 mbar = 0.00099 atm. (atmosphere)	1 atm. (atmosphere) = 1013 mbar

Velocity

1 m/s = 196.85 ft./min (feet/min)	1 ft./min (foot/min) = 0.00508 m/s
1 km/h = 0.6214 mph (mile/h)	1 mph (mile/h) = 1.609 km/h

Power / energy

1 kW = 3412 Btu/h	1 Btu/h = 0.000293 kW
1 J/kg = 0.00043 Btu/h	1 Btu/h = 2326 J/kg

Miscellaneous

1 kW = 1.34 h.p.	0.746 h.p. = 1 kW
1 m ³ /kg = 16.03 ft ³ /lb	1 ft ³ /lb = 0.0624 m ³ /kg
1 m/s = 0.194 knot	1 knot = 5.148 m/s
1 km = 0.5396 naut. mile	1 naut. mile = 1.8532 km
°C = (°F-32)*5/9	°F = (°C*9/5)+32
°C = K+273	K = °C-273

Index

A-Z	Page
GreenTech	2
Our trade marks.	2
Contents	3
Areas of application	2
Fans from ebm-papst	4
Designs	4-5
Airflow direction	6
Performance ranges	7
Fan types	8
Selection criteria	9
Components	10-11
Type code	12
Software	13
Axial fans from ebm-papst	14-29
Facts	16
Performance ranges	17
Selection criteria	18-19
Impellers	20
Versions	21
Fan housing and nozzle	22-23
Guard grill	24-25
Intake obstructions	26
Outlet obstructions	27
Diffuser	28-29
Centrifugal fans from ebm-papst	30-47
Facts	32
Performance range	33
Selection criteria	33-35
Centrifugal fans, forward and backward-curved	36-41
Product ranges	37
Inlet ring	38
Effects	39-41
Centrifugal fans with scroll housing	42-47
Impellers	43
Scroll housing	44
Product ranges	45
Effects	46-47
Diagonal fans from ebm-papst	48-55
Facts	50
Performance ranges	51
Selection criteria	52-53

A-Z	Page
Product ranges	54
Effects	55
Tangential blowers from ebm-papst	56-61
Facts	58
Performance ranges	59
Selection criteria	60-61
Motors from ebm-papst	62-71
Characteristic features of EC and AC motors	64
Efficiency levels of EC and AC motors	65
EC motors from ebm-papst	66-67
AC motors from ebm-papst	68-70
Control electronics from ebm-papst	72-85
Open-loop control of EC motors	76-83
Open-loop control of AC motors	84-85
Appendix	96-127
Speed	88
Impeller diameter	89
Outlet width	90
Air density	91
General performance parameters	92-99
Service life	92
Standards & approvals	92
Mechanical stresses	93
Vibration test	93
Shock load	93
Chemical/physical stresses	93
Flammability classes	93
Materials	93
Balancing grade	93
Environmental classes	94
Installation position and condensation drainage hole	94
Corrosion protection	95
Winding impregnation	95
Degree of protection	96
Insulation class	97
Motor protection/thermal protection	97
Mode of operation	98
Protection class	98
Explosion protection	99
Performance measurement	100-102
Installation category	102

A-Z	Page
Accuracy classes	102
Drive power and efficiency	102
Aerodynamics	104-105
Air flow	104
Pressure	105
Acoustics	106-109
Sound pressure and sound pressure level	106
Distance laws	106
Sound power level	107-109
Operating point	110-111
Performance	110
Efficiency	111
Efficiency figures	112
Part load compensation factor	112
SFP Specific fan power	112
Electronics and EMC	114-116
Power factor	114
Power factor correction	115
THD value	116
Electrical quantities	117-108
Calculation of electric power	117
Synchronous speed of AC motors	118
Slip	118
Electronics and EMC	119
Surge and burst	119
ESD	119
Definition of nominal voltage	119
EMC	119
Standard voltages and networks	120
Physical quantities, symbols, units	122-124
Index	126-127