

ebm-papst Mulfingen GmbH & Co. KG

Bachmühle 2

D-74673 Mulfingen

Phone +49 (0) 7938 81-0

Fax +49 (0) 7938 81-110

info1@de.ebmpapst.com

www.ebmpapst.com

## CONTENTS

<b>1. SAFETY REGULATIONS AND NOTES</b>	<b>1</b>
1.1 Levels of hazard warnings	1
1.2 Staff qualification	1
1.3 Basic safety rules	1
1.4 Electrical voltage	1
1.5 Safety and protective functions	2
1.6 Electromagnetic radiation	2
1.7 Mechanical movement	2
1.8 Emission	2
1.9 Hot surface	2
1.10 Transport	2
1.11 Storage	2
1.12 Disposal	3
<b>2. PROPER USE</b>	<b>3</b>
<b>3. TECHNICAL DATA</b>	<b>4</b>
3.1 Product drawing	4
3.2 Nominal data	5
3.3 Data according to ErP directive	5
3.4 Technical features	5
3.5 Mounting data	5
3.6 Transport and storage conditions	6
3.7 Electromagnetic compatibility	6
<b>4. CONNECTION AND START-UP</b>	<b>6</b>
4.1 Connecting the mechanical system	6
4.2 Connecting the electrical system	6
4.3 Connection in terminal box	7
4.4 Factory settings	8
4.5 Connection screen	9
4.6 Checking the connections	10
4.7 Switch on device	10
4.8 Switching off the device	10
<b>5. INTEGRATED PROTECTIVE FUNCTIONS</b>	<b>10</b>
<b>6. MAINTENANCE, MALFUNCTIONS, POSSIBLE CAUSES AND REMEDIES</b>	<b>11</b>
6.1 Cleaning	12
6.2 Safety test	12

## 1. SAFETY REGULATIONS AND NOTES

Please read these operating instructions carefully before starting to work with the device. Observe the following warnings to prevent malfunctions or physical damage to both property and people.

These operating instructions are to be regarded as part of this device.

If the device is sold or transferred, the operating instructions must accompany it.

These operating instructions may be duplicated and forwarded for information about potential dangers and their prevention.

### 1.1 Levels of hazard warnings

These operating instructions use the following hazard levels to indicate potentially hazardous situations and important safety regulations:



#### DANGER

Indicates an imminently hazardous situation which, if not avoided, will result in death or serious injury. Compliance with the measures is mandatory.

#### WARNING

Indicates a potentially hazardous situation which, if not avoided, could result in death or serious injury. Exercise extreme caution while working.

#### CAUTION

Indicates a potentially hazardous situation which, if not avoided, may result in minor or moderate injury or damage of property.

#### NOTE

A potentially harmful situation can occur and, if not avoided, can lead to property damage.

### 1.2 Staff qualification

The device may only be transported, unpacked, installed, operated, maintained and otherwise used by qualified, trained and authorised technical staff.

Only authorised specialists are permitted to install the device, to carry out a test run and to perform work on the electrical installation.

### 1.3 Basic safety rules

Any safety hazards stemming from the device must be re-evaluated once it is installed in the end device.

Observe the following when working on the unit:

- ⇒ Do not make any modifications, additions or conversions to the device without the approval of ebm-papst.

### 1.4 Electrical voltage

- ⇒ Check the electrical equipment of the device at regular intervals, refer to chapter 6.2 Safety test.

- ⇒ Replace loose connections and defective cables immediately.

#### WARNING

**Terminals and connections have voltage even with a unit that is shut off**

Electric shock

- Wait five minutes after disconnecting the voltage at all poles before opening the device.

#### CAUTION

**In the event of failure, there is electric voltage at the rotor and impeller**

The rotor and impeller are base insulated.

- Do not touch the rotor and impeller once they are installed.

**CAUTION**

If control voltage is applied or a speed setpoint is stored, the motor automatically restarts, e.g. after a power failure.

Danger of injury

- Keep out of the danger zone of the device.
- When working on the device, switch off the mains supply voltage and secure the latter from being switched on again.
- Wait until the device stops.
- After working on the device, remove any used tools or other objects from the device.

**1.5 Safety and protective functions****DANGER**

**Missing safety device and non-functioning safety device**

If there is no safety device, you could be seriously injured, for example if you reach into the running device or your hands are sucked into it.

- Operate the device only with a fixed and isolating safety protection and a fixed guard grille.  
The guard must withstand the kinetic energy of a fan blade detaching at maximum speed.
- The device is a built-in component. You, the owner/operator, are responsible for providing adequate protection for the device.
- Shut down the device immediately if you detect a missing or ineffective protective feature.

**1.6 Electromagnetic radiation**

Interference from electromagnetic radiation is possible, e.g. in conjunction with open and closed-loop control devices.

If unacceptable emission intensities occur when the fan is installed, appropriate shielding measures have to be taken by the user.

**NOTE**

**Electrical or electromagnetic interferences after integrating the device in installations on the customer's side.**

- Verify that the entire setup is EMC compliant.

**1.7 Mechanical movement****DANGER**

**Rotating device**

Body parts that come into contact with the rotor and impeller can be injured.

- Secure the device against accidental contact.
- Before working on the system/machine, wait until all parts have come to a standstill.

**DANGER**

**Flying parts**

Missing safety devices may cause balancing weights or broken fan blades to be ejected at high speeds, causing bodily harm.

- Take appropriate safety measures.

**WARNING**

**Rotating device**

Long hair, loose items of clothing and jewellery could become entangled and pulled into the device. You could be injured.

- Do not wear any loose clothing or jewellery while working on rotating parts.
- Protect long hair by wearing a cap.

**1.8 Emission****WARNING**

**Depending on the installation and operating conditions, a sound pressure level greater than 70 dB(A) may arise.**

Danger of noise-induced hearing loss

- Take appropriate technical safety measures.
- Protect operating personnel with appropriate safety equipment, e.g. hearing protection.
- Also observe the requirements of local agencies.

**1.9 Hot surface****CAUTION**

**High temperature at the electronics enclosure**

Danger of burn injuries

- Ensure that sufficient protection against accidental contact is provided.

**1.10 Transport****WARNING**

**Transport of fan**

Injuries from slipping or falling.

- Only transport the fan in its original packaging. # Transport the fan "lying flat", in other words with the axis vertical.
- Secure the fan(s) so that nothing can slip or fall, for example using a lashing strap.

**1.11 Storage**

- ⇒ Store the device, partially or fully assembled, in a dry and weatherproof manner in the original packing in a clean environment.
- ⇒ Protect the device from environmental impacts and dirt until the final installation.
- ⇒ We recommend storing the device for a maximum up to one year to guarantee proper operation and longest possible service life.
- ⇒ Even devices explicitly suited for outdoor use are to be stored as described prior to being commissioned.
- ⇒ Maintain the storage temperature, see chapter 3.6 Transport and storage conditions.
- ⇒ Please make sure that all screwed cable glands are fitted with dummy plugs.

### 1.12 Disposal

When disposing of the device, please comply with all relevant requirements and regulations applicable in your country.

## 2. PROPER USE

The device is exclusively designed as a built-in device for conveying air according to its technical data.

Any other usage above and beyond this does not conform with the intended purpose and constitutes misuse of the device.

Customer equipment must be capable of withstanding the mechanical and thermal stresses that can arise from this product. This applies for the entire service life of the equipment in which this product is installed.

#### Proper use also includes:

- Use the device in power systems with earthed neutral (TN/TT power systems) only.
- Only using the device in stationary systems.
- Carrying out all maintenance.
- Moving air with a density of 1.2 kg/m<sup>3</sup>.
- Using the device in accordance with the permitted ambient temperature, see chapter 3.6 Transport and storage conditions and chapter 3.2 Nominal data.
- Operating the device with all protective features in place.
- Minding the operating instructions.

#### Improper use

Using the device in the following ways is particularly prohibited and may cause hazards:

- Operating the device with an imbalance, e.g. caused by dirt deposits or icing.
- Operation in medical equipment with a life-sustaining or lifesaving function.
- Operation with external vibrations.
- Moving solids content in flow medium.
- Painting the device
- Connections (e.g. screws) coming loose during operation.
- Opening the terminal box during operation.
- Moving air that contains abrasive particles.
- Moving highly corrosive air, e.g. salt spray mist. Exceptions are devices that are intended for salt spray mist and protected accordingly.
- Moving air that contains dust pollution, e.g. suctioning off saw dust.
- Operating the device close to flammable materials or components.
- Operating the device in an explosive atmosphere.
- Using the device as a safety component or for taking on safety-related functions.
- Operation with completely or partially disassembled or modified protective features.
- In addition, all application options that are not listed under proper use.

## 3. TECHNICAL DATA

### 3.1 Product drawing

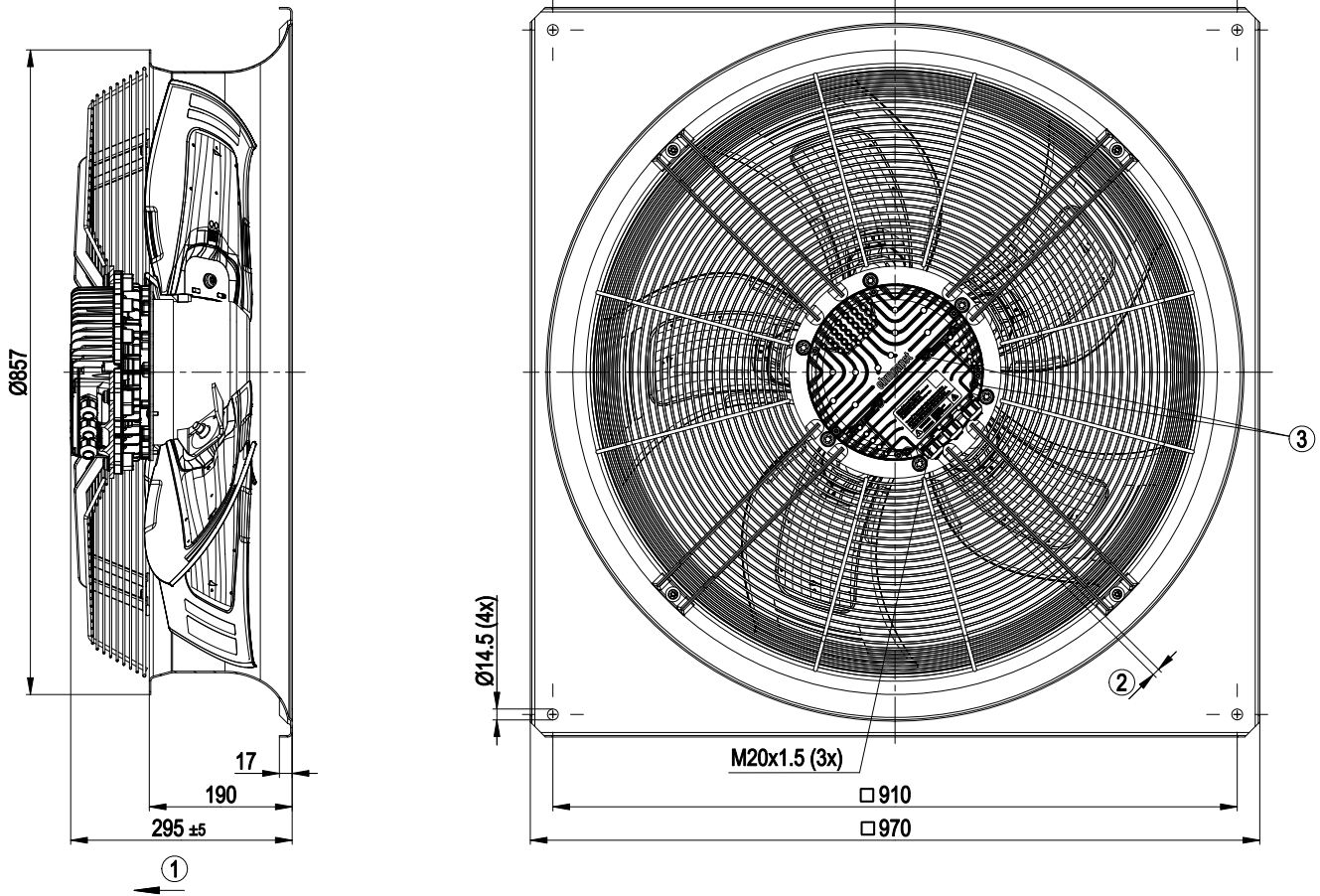

All measures have the unit mm.

1	Direction of air flow "V"
2	Cable diameter: min. 4 mm, max. 10 mm, tightening torque: $4 \pm 0.6$ Nm
3	Tightening torque $3.5 \pm 0.5$ Nm

## 3.2 Nominal data

Motor	M3G150-GF
Phase	3~
Nominal voltage / VAC	400
Nominal voltage range / VAC	380 .. 480
Frequency / Hz	50/60
Type of data definition	ml
Speed / min <sup>-1</sup>	925
Power input / W	1850
Current draw / A	2.85
Min. ambient temperature / °C	-25
Max. ambient temperature / °C	65

ml = Max. load · me = Max. efficiency · fa = Running at free air  
cs = Customer specs · cu = Customer unit

Subject to alterations

## 3.3 Data according to ErP directive

Installation category	A
Efficiency category	Static
Variable speed drive	Yes
Specific ratio*	1.00

\* Specific ratio =  $1 + p_{is} / 100\,000\text{ Pa}$

	Actual	Request 2013	Request 2015
Overall efficiency $\eta_{es}$ / %	42.9	31.1	35.1
Efficiency grade N	47.8	36	40
Power input $P_{ed}$ / kW	1.68		
Air flow $q_v$ / m <sup>3</sup> /h	15810		
Pressure increase total $p_{sf}$ / Pa	154		
Speed $n$ / min <sup>-1</sup>	930		

Data definition with optimum efficiency.

The ErP data is determined using a motor-impeller combination in a standardised measurement configuration.

## 3.4 Technical features

Mass	42.8 kg
Size	800 mm
Surface of rotor	Coated in black
Material of electronics housing	Die-cast aluminium, coated in black
Material of blades	Aluminium sheet insert, sprayed with PP plastic
Material of wall ring	Sheet steel, pre-galvanised and coated in black plastic (RAL 9005)
Material of guard grille	Steel, coated in black plastic (RAL9005)
Number of blades	5
Blade angle	0°
Direction of air flow	"V"
Direction of rotation	Clockwise, seen on rotor
Type of protection	IP 54
Insulation class	"F"
Humidity class	F4-1

Mounting position	Shaft horizontal or rotor on bottom; rotor on top on request
Condensate discharge holes	Rotor-side
Operation mode	S1
Motor bearing	Ball bearing
Technical features	<ul style="list-style-type: none"> <li>- Output 10 VDC, max. 10 mA</li> <li>- Output 20 VDC, max. 50 mA</li> <li>- Output for slave 0-10 V</li> <li>- Input for sensor 0-10 V or 4-20 mA</li> <li>- External 24 V input (programming)</li> <li>- External release input</li> <li>- Alarm relay</li> <li>- Integrated PID controller</li> <li>- Motor current limit</li> <li>- PFC, passive</li> <li>- RS485 MODBUS RTU</li> <li>- Soft start</li> <li>- Control input 0-10 VDC / PWM</li> <li>- Control interface with SELV potential safely disconnected from the mains</li> <li>- Over-temperature protected electronics / motor</li> <li>- Line undervoltage / phase failure detection</li> </ul>
Touch current acc. IEC 60990 (measuring network Fig. 4, TN system)	<= 3.5 mA
Electrical leads	Via terminal box
Motor protection	Reverse polarity and locked-rotor protection
Protection class	I (if protective earth is connected by customer)
Product conforming to standard	EN 61800-5-1; CE
Approval	C22.2 Nr.77 + CAN/CSA-E60730-1; EAC; UL 1004-7 + 60730



For cyclic speed loads, note that the rotating parts of the device are designed for maximum one million load cycles. If you have specific questions, contact ebm-papst for support.

## 3.5 Mounting data

⇒ Secure the mounting screws against accidentally coming loose (e.g. by using self-locking screws).

Strength class for mounting screws	8.8
------------------------------------	-----

You can obtain additional mounting data from the product drawing if necessary.

### 3.6 Transport and storage conditions

⇒ Use the device in accordance with its protection type.

Max. permissible ambient motor temp. (transp./ storage)	+ 80 °C
Min. permissible ambient motor temp. (transp./storage)	- 40 °C

### 3.7 Electromagnetic compatibility

EMC interference immunity	Acc. to EN 61000-6-2 (industrial environment)
EMC interference emission	Acc. to EN 55022 (Class B, household environment)



If several devices are switched in parallel on the mains side so that the line current of the arrangement is in the range of 16 - 75 A, then this arrangement conforms to IEC 61000-3-12 provided that the short-circuit power  $S_{sc}$  at the connection point of the customer system to the public power system is greater than or equal to 120 times the rated output of the arrangement. It is the responsibility of the installation engineer or operator/owner of the device to ensure, if necessary after consultation with the network operator, that this device is only connected to a connection point with a  $S_{sc}$  value that is greater than or equal to 120 times the rated output of the arrangement.

## 4. CONNECTION AND START-UP

### 4.1 Connecting the mechanical system



#### CAUTION

**Cutting and crushing hazard when removing the device from the packaging**

Blades can be bent



→ Carefully remove the device from its packaging, only touching the wall ring. Make sure to avoid any shock.

→ Wear safety shoes and cut-resistant safety gloves.

#### CAUTION

**Heavy load when taking out the device**

Bodily harm, e.g. back injuries, are possible.

→ Two people should remove the device out of its packaging together.

⇒ Check the device for transport damage. Damaged devices must no longer be installed.

⇒ Install the undamaged device according to your application.

### 4.2 Connecting the electrical system



#### DANGER

**Electric voltage on the device**

Electric shock

→ Always install a protective earth first.

→ Check the protective earth.



#### DANGER

**Incorrect insulation**

Risk of fatal injury from electric shock

→ Use only cables that meet the specified installation requirements for voltage, current, insulation material, load etc.

→ Route cables such that they cannot be touched by any rotating parts.



#### DANGER

**Electrical load (>50 µC) between mains wire and protective earth connection after switching of the supply when switching multiple devices in parallel.**

Electric shock, risk of injury

→ Make sure that sufficient protection against accidental contact is provided.

Before working on the electrical connection, the connections to the mains supply and PE must be shorted.

#### CAUTION

**Electrical voltage**

The fan is a built-in component and features no electrically isolating switch.

→ Only connect the fan to circuits that can be switched off with an all-pole separating switch.

→ When working on the fan, you must switch off the installation/machine in which the fan is installed and secure it from being switched on again.

#### NOTE

**Interferences and failures are possible**

Maintain a distance to the power supply line when routing the control lines of the device.



→ Ensure a sufficiently large clearance.  
 Recommendation: clearance > 10 cm (separate cable routing)

**NOTE**

**Water penetration into leads or wires**

Water enters at the cable end on the customers side and can damage the device.

→ Make sure that the cable end is connected in a dry environment.



Connect the device only to circuits that can be switched off using an all-pole disconnecting switch.

**4.2.1 Prerequisites**

- ⇒ Check whether the data on the type plate agree with the connection data.
- ⇒ Before connecting the device, ensure that the supply voltage matches the operating voltage of the device.
- ⇒ Only use cables designed for current according to the type plate. For determining the cross-section, follow the basic principles in accordance with EN 61800-5-1. The protective earth must have a cross-section equal to or greater than the outer conductor cross-section. We recommend the use of 105°C cables. Ensure that the minimum cable cross-section is at least AWG26/0.13 mm².

**Earth wire contact resistance to EN 61800-5-1**

Compliance with the impedance specifications to EN 61800-5-1 for the protective earth circuit must be verified in the end application. Depending on the installation situation, it may be necessary to install an additional protective earthing conductor via the additional protective earth connection point available on the device. The protective earth connection point is located on the housing and has a protective earth symbol and a bore hole.

**4.2.2 Power supply connection, fuse protection**

Assignment of conductor cross-sections and the fuse protection required for them (overload protection only, no device protection).

Nominal voltage	Safety fuse		Automatic circuit breaker	Wire cross-section	Wire cross-section
	VDE	UL	VDE	mm²	*AWG
3/PE AC 380 - 480 VAC	16 A	15 A	C16A	1.5	16
3/PE AC 380 - 480 VAC	20 A	20 A	C20A	2.5	14
3/PE AC 380 - 480 VAC	25 A	25 A	C25A	4.0	12
3/PE AC 380 - 480 VAC	32 A	30 A	C32A	6.0	10

\* AWG = American Wire Gauge

**4.2.3 Idle current**



Because of the EMC filter integrated for compliance with EMC limits (interference emission and interference immunity), idle currents in the mains cable can be measured even when the motor is at a standstill and the mains voltage is switched on.

- The values lie in a range of typical < 250 mA.
- The effective power in this operating state (readiness for operation) is simultaneously at typical < 5 W.

**4.2.4 Residual current operated device**



Only universal (type B or B+) RCD protective devices are permitted. Like frequency inverters, RCD protective devices cannot provide personal safety while operating the device. When switching on the power supply of the device, pulsed charge currents from the capacitors in the integrated EMC filter can lead to the RCD protective devices triggering without delay. We recommend residual current devices with a trigger threshold of 300 mA and delayed triggering (super-resistant, characteristic K).

**4.2.5 Leakage current**



For asymmetrical power systems or if a phase fails, the leakage current can increase to a multiple of the nominal value.

**4.2.6 Locked-rotor protection**



Due to the locked-rotor protection, the start-up current (LRA) is equal to or less than the nominal current (FLA).

**4.3 Connection in terminal box**

**4.3.1 Preparing connection lines for the connection**

Strip the cable just enough so that the screwed cable gland is tight and the terminals are relieved of strain. Tightening torque, see chapter 3.1 Product drawing.

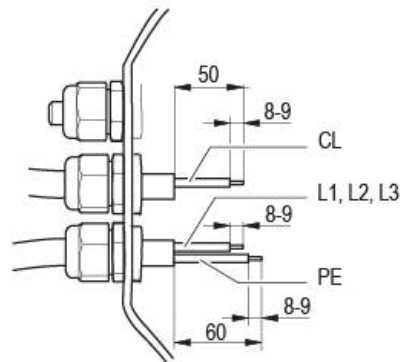

Fig. 1: Recommended stripping lengths in mm (inside the terminal box)  
 Legend: CL = control lines



### 4.3.2 Connecting cables with terminals

**WARNING**

**Terminals and connections have voltage even with a unit that is shut off**

Electric shock

→ Wait five minutes after disconnecting the voltage at all poles before opening the device.

⇒ Remove the cap from the screwed cable gland.

Remove the cap only in those places where cables are inserted.

⇒ Mount the screwed cable glands with the seal inserts provided in the terminal box.

⇒ Insert the line(s) (not included in the standard scope of delivery) into the terminal box.

⇒ First connect the "PE" (protective earth) connection.

⇒ Connect the lines to the corresponding terminals.

Use a screwdriver to do so.

During the connection work, ensure that no cables splice off.

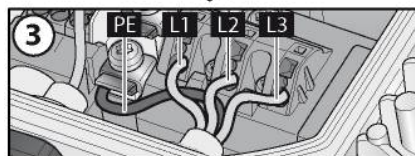
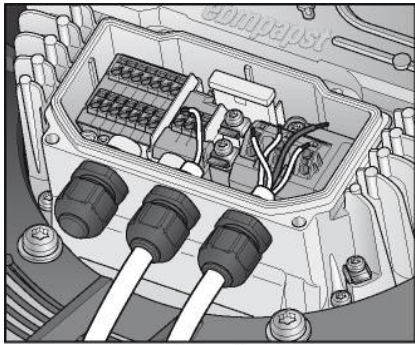

Fig. 2: Connecting the wires to terminals

⇒ Seal the terminal box.

### 4.3.3 Cable routing

No water may penetrate along the cable in the direction of the cable gland.

#### Fans installed lying flat

Make sure that the cable is routed in the form of a loop (water trap).

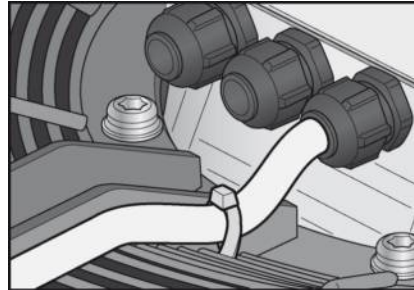

Fig. 3: Fan installed lying flat, cable routed as a water trap.

#### Fans installed in upright position

When routing the cable, ensure that the screwed cable glands are arranged at the bottom. The cables must always be routed downwards.

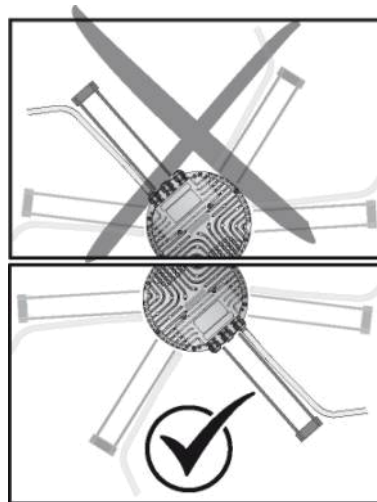

Fig. 4: Cable routing for fans installed upright.

### 4.4 Factory settings

Factory settings with which the device is pre-set by ebm-papst.

Control mode parameter set 1	PWM controlling
Control mode parameter set 2	PWM controlling
Fan / device address	1
Max. PWM / %	100
Min. PWM / %	5
Save set value to EEPROM	Yes
Set value control	Analogue (linear)
Control function parameter set 1	Positive (heating)
Control function parameter set 2	Positive (heating)





## 4.5 Connection screen

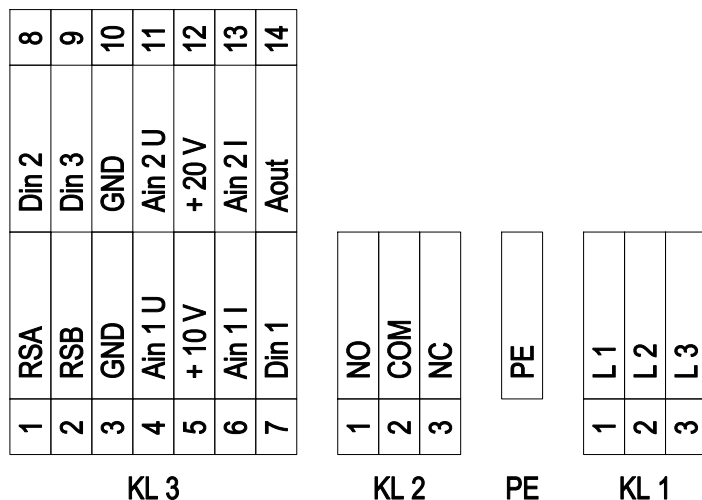

No.	Conn.	Designation	Function / assignment
KL 1	1	L1	Mains supply connection, supply voltage 3~380-480 VAC; 50/60 Hz
KL 1	2	L2	Mains supply connection, supply voltage 3~380-480 VAC; 50/60 Hz
KL 1	3	L3	Mains supply connection, supply voltage 3~380-480 VAC; 50/60 Hz
PE		PE	Earth connection, PE connection
KL 2	1	NO	Status relay, floating status contact; normally open; close with error
KL2	2	COM	Status relay; floating status contact; changeover contact; common connection; contact rating 250 VAC / max. 2 A (AC1) / min. 10 mA
KL2	3	NC	Status relay, floating status contact; break with error
KL 3	1	RSA	Bus connection RS-485, RSA, MODBUS RTU; SELV
KL 3	2	RSB	Bus connection RS-485, RSB, MODBUS RTU; SELV
KL 3	3 / 10	GND	Signal ground for control interface; SELV
KL 3	4	Ain1 U	Analogue input 1, set value: 0-10 V, Ri = 100 kΩ, parametrisable curve, only usable as alternative to input Ain1; SELV
KL 3	5	+ 10 V	Fixed voltage output 10 VDC, +10 V ±3%, max. 10 mA, short-circuit-proof, power supply for external devices (e.g. potentiometer), SELV
KL 3	6	Ain1 I	Analogue input 1, set value: 4-20 mA; Ri = 100 Ω, parametrisable curve, only usable as alternative to input Ain1 U; SELV
KL 3	7	Din1	Digital input 1: enabling of electronics, enabling: open pin or applied voltage 5-50 VDC disabling: bridge to GND or applied voltage <1 VDC reset function: triggers software reset after a level change to <1 VDC; SELV
KL 3	8	Din2	Digital input 2: parameter set switch 1/2, according to EEPROM setting, the valid/used parameter set can be selected via bus or via digital input DIN2. Parameter set 1: open pin or applied voltage 5-50 VDC Parameter set 2: bridge to GND or applied voltage <1 VDC; SELV
KL 3	9	Din3	Digital input 3: controller function of integrated controller, according to EEPROM setting, the controller function of the integrated controller is normally/inversely selectable per bus or per digital input normal: open pin or applied voltage 5-50 VDC inverse: bridge to GND or applied voltage <1 VDC; SELV
KL 3	11	Ain2 U	Analogue input 2, actual value: 0-10 V, Ri = 100 kΩ, parametrisable curve, only usable as alternative to input Ain2; SELV
KL 3	12	+ 20 V	Fixed voltage output 20 VDC, +20 V +25/-10%, max. 50 mA, short-circuit-proof, power supply for external devices (e.g. sensors); SELV
KL 3	13	Ain2 I	Analogue input 2, actual value: 4-20 mA, Ri = 100 Ω, parametrisable curve, only usable as alternative to input Ain2 U; SELV
KL 3	14	Aout	Analogue output 0-10 VDC, max. 5 mA, output of the current motor level control coefficient / motor speed parametrisable curve; SELV

#### 4.6 Checking the connections

- ⇒ Make sure that the power is off (all phases).
- ⇒ Secure it from being switched on again.
- ⇒ Check the correct fit of the connection lines.
- ⇒ Screw the terminal box cover closed again. Terminal box tightening torque, see chapter 3.1 Product drawing.
- ⇒ Route the connecting cables in the terminal box so that the terminal box cover closes without resistance.
- ⇒ Use all plug screws (the entire number). In doing so, insert the screws manually to avoid damage to the thread.
- ⇒ Make sure that the terminal box is correctly closed and sealed and that all screws and screwed cable glands are properly tightened.

#### 4.7 Switch on device

The device may only be switched on if it has been installed properly and in accordance with its intended use, including the required safety mechanisms and professional electrical connection. This also applies for devices which have already been equipped with plugs and terminals or similar connectors by the customer.



**WARNING**  
**Hot motor housing**  
 Fire hazard

→ Ensure that no combustible or flammable materials are located close to the fan.

- ⇒ Inspect the device for visible external damage and the proper function of the protective features before switching it on.
- ⇒ Check the air flow paths of the fan for foreign objects and remove any that are found.
- ⇒ Apply the nominal voltage to the voltage supply.
- ⇒ Start the device by changing the input signal.

#### 4.8 Switching off the device

Switching off the device during operation:

- ⇒ Switch off the device via the control input.
- ⇒ Do not switch the motor (e.g. in cyclic operation) on and off via power supply.

Switching off the device for maintenance work:

- ⇒ Switch off the device via the control input.
- ⇒ Do not switch the motor (e.g. in cyclic operation) on and off via power supply.
- ⇒ Disconnect the device from the supply voltage.
- ⇒ When disconnecting, be sure to disconnect the earth wire connection last.

#### 5. INTEGRATED PROTECTIVE FUNCTIONS

The integrated protective functions cause the motor to switch off automatically in case of faults described in the table.

Malfunctions	Description / Function of safety feature
Rotor position detection error	An automatic restart occurs.
Locked rotor	⇒ After the blockage is removed, the motor restarts automatically.
Line under-voltage (mains input voltage outside of permitted nominal voltage)	⇒ If the mains supply voltage returns to permitted values, the motor restarts automatically.
Phase failure	A phase of the supply voltage fails for at least 5 s. ⇒ If all phases are correctly supplied again, the motor automatically restarts after 10 - 40 s.

## 6. MAINTENANCE, MALFUNCTIONS, POSSIBLE CAUSES AND REMEDIES

Do not perform any repairs on your device. Return the device to ebm-papst for repair or replacement.

### WARNING

**Terminals and connections have voltage even with a unit that is shut off**

Electric shock

- Wait five minutes after disconnecting the voltage at all poles before opening the device.

### CAUTION

**If control voltage is applied or a speed setpoint is stored, the motor automatically restarts, e.g. after a power failure.**

Danger of injury

- Keep out of the danger zone of the device.
- When working on the device, switch off the mains supply voltage and secure the latter from being switched on again.
- Wait until the device stops.
- After working on the device, remove any used tools or other objects from the device.



If the device remains out of use for over four months, we recommend switching the device on for at least three hours at full speed to allow any condensate to evaporate and to move the bearings.

Malfunction/error	Possible cause	Possible remedy
<b>Impeller running roughly</b>	Imbalance in rotating parts	Clean the device; if imbalance is still evident after cleaning, replace the device. If you have attached any weight clips during cleaning, make sure to remove them afterwards.
<b>Motor does not turn</b>	Mechanical blockage	Switch off, de-energise, and remove mechanical blockage.
	Mains supply voltage faulty	Check mains supply voltage, restore power supply. Important! The error message resets automatically. The device starts up again automatically without advance warning.
	Faulty connection	De-energise, correct connection, see connection diagram.
	Motor winding broken	Replace device

	Insufficient cooling	Improve cooling. Let the device cool down. To reset the error message, switch off the mains supply voltage for a min. of 25 s and switch it on again. Alternatively, reset the error message by applying a control signal of <0.5 V to DIN1 or by short circuiting Din1 to GND.
	Ambient temperature too high	Reduce the ambient temperature. Let the device cool down. To reset the error message, switch off the mains supply voltage for a min. of 25 s and switch it on again. Alternatively, reset the error message by applying a control signal of <0.5 V to DIN1 or by short circuiting Din1 to GND.
	Unacceptable operating point (e.g. counterpressure is too high)	Correct the operating point. Let the device cool down. To reset the error message, switch off the mains supply voltage for a min. of 25 s and switch it on again. Alternatively, reset the error message by applying a control signal of <0.5 V to DIN1 or by short circuiting Din1 to GND.



If you have any other problems, contact ebm-papst.



## 6.1 Cleaning

### NOTE

#### Damage to the device during cleaning.

Malfunction possible

- Do not clean the device using a water jet or high-pressure washer.
- Do not use any cleaners containing acids, bases or solvents.
- Do not use any pointed or sharp-edged objects to clean.

## 6.2 Safety test

### NOTE

#### High-voltage test

The integrated EMC filter contains Y capacitors. Therefore, the trigger current is exceeded when AC testing voltage is applied.

- Test the device with DC voltage when you carry out the high-voltage test required by law. The voltage to be used corresponds to the peak value of the AC voltage required by the standard.

What has to be tested?	How to test?	Frequency	Which measure?
Check the protective casing against accidental contact for damage and to ensure that it is intact	Visual inspection	At least every 6 months	Repair or replacement of the device
Check the device for damage to blades and housing	Visual inspection	At least every 6 months	Replacement of the device
Mounting the connection lines	Visual inspection	At least every 6 months	Fasten
Check the insulation of the wires for damage	Visual inspection	At least every 6 months	Replace wires
Tightness of screwed cable gland	Visual inspection	At least every 6 months	Retighten, replace if damaged
Condensate discharge holes for clogging, as necessary	Visual inspection	At least every 6 months	Open bore holes
Weld seams for crack formation	Visual inspection	At least every 6 months	Replace device