



ebm-papst Mulfingen GmbH & Co. KG

Bachmühle 2
 D-74673 Mulfingen
 Phone +49 (0) 7938 81-0
 Fax +49 (0) 7938 81-110
 info1@de.ebmpapst.com
 www.ebmpapst.com

CONTENTS

1. STANDARDS AND DIRECTIVES	1
1.1 Applied standards and directives	1
2. SAFETY REGULATIONS AND NOTES	2
2.1 Levels of hazard warnings	2
2.2 Staff qualification	2
2.3 Basic safety rules	2
2.4 Electrical voltage	2
2.5 Safety and protective functions	2
2.6 Electromagnetic radiation	3
2.7 Mechanical movement	3
2.8 Emission	3
2.9 Hot surface	3
2.10 Transport	3
2.11 Storage (including stockkeeping of spare parts)	3
2.12 Disposal	4
3. PROPER USE	4
4. TECHNICAL DATA	5
4.1 Product drawing	5
4.2 Nominal data	6
4.3 Technical features	6
4.4 Mounting data	6
4.5 Transport and storage conditions	6
4.6 Electromagnetic compatibility	7
4.7 Ex areas	7
4.8 The type plate	7
5. CONNECTION AND START-UP	8
5.1 Connecting the mechanical system	8
5.2 Connecting the electrical system	8
5.3 Connection in terminal box	10
5.4 Factory settings	12
5.5 Connection screen	13
5.6 Checking the connections	14
5.7 Switch on device	14
5.8 Switching off the device	14
6. INTEGRATED PROTECTIVE FUNCTIONS	14
7. MAINTENANCE, MALFUNCTIONS, POSSIBLE CAUSES AND REMEDIES	14
7.1 Cleaning	15
7.2 Safety test	15
7.3 Maintenance interval	15
7.4 Vibration check	16

1. STANDARDS AND DIRECTIVES

1.1 Applied standards and directives

As per directive 2014/34/EU in accordance with the following standards:

EN 14986: 2007

Design of fans for use in potentially explosive atmospheres

EN 60079-0: 2012

Explosive atmospheres

Part 0: Equipment - General requirements

EN 60079-1: 2007

Explosive atmosphere Part 1: Equipment protection by pressure-resistant enclosure "d"

EN 60079-7: 2007

Explosive atmosphere Part 7: Equipment protection by increased safety "e"

EN 60079-11: 2012

Explosive atmosphere Part 11: Equipment protection by intrinsic safety "i"

TR CU 012/2011

The fan satisfies the requirements of the Technical Regulations of the Customs Union "On safety of equipment intended for use in explosive atmospheres".

These operating instructions are available in other languages on our website, www.ebmpapst.com.



2. SAFETY REGULATIONS AND NOTES

Read the operating instructions carefully before working on the device and every time before using it. Observe the following safety instructions to prevent malfunctions or danger to persons. These operating instructions are to be regarded as part of the device. Keep the operating instructions close to the product so that users can access them at any time. The device may only be sold or passed on together with the operating instructions. The operating instructions must be accessible for the operating and maintenance personnel. These operating instructions may be duplicated and forwarded for information about potential dangers and their prevention.

2.1 Levels of hazard warnings

These operating instructions use the following hazard levels to indicate potentially hazardous situations and important safety regulations:



DANGER

Indicates an imminently hazardous situation which, if not avoided, will result in death or serious injury. Compliance with the measures is mandatory.

WARNING

Indicates a potentially hazardous situation which, if not avoided, could result in death or serious injury. Exercise extreme caution while working.

CAUTION

Indicates a potentially hazardous situation which, if not avoided, may result in minor or moderate injury or damage of property.

NOTE

A potentially harmful situation can occur and, if not avoided, can lead to property damage.

2.2 Staff qualification

Only electricians specialising in electrical explosion protection may install the device, perform the test run and work on the electrical system. The device may only be unpacked, operated, switched on or off, set, used, run, disassembled and transported by suitable, qualified, trained and authorised personnel.

2.3 Basic safety rules

A risk assessment in accordance with the Industrial Safety Regulation (BetrSichV) must be performed before any use of the device. The safety hazards associated with the device must be assessed again following installation in the final product.

Observe the following when working on the unit:

- ⇒ The device is only to be used in proper technical working order for its intended purpose, in a safe manner with attention to potential dangers and in accordance with the operating instructions.
- ⇒ Any faults and defects which impair safety must be rectified immediately.
- ⇒ Do not make any modifications, additions or conversions to the device (such as modifying the guard grille or attaching other equipment to the wall ring) without the approval of ebm-papst.
- ⇒ Modifications to the device result in loss of Ex approval. ebm-papst Mulfingen GmbH & Co. KG does not accept any liability for resultant damage.

2.4 Electrical voltage

- ⇒ Check the electrical equipment of the device at regular intervals; see chapter 7.2 Safety test.
- ⇒ Replace loose connections and defective cables immediately.



DANGER

Live terminals and connections even with device switched off

Electric shock, unintentional triggering of an ignition spark and capacitive residual voltage can cause an ignition spark in the event of a short circuit.

→ Before disconnecting the wires in the terminal box, short-circuit the wires (L1, L2, L3) and PE outside the explosion-hazard area, see chapter 5.8.2 Switching off the device for maintenance work. #Wait five minutes following all-pole disconnection of the voltage before opening the terminal box.

CAUTION

In the event of failure, there is electric voltage at the rotor and impeller

The rotor and impeller are base insulated.

- Do not touch the rotor and impeller once they are installed.

CAUTION

If control voltage is applied or a speed setpoint is stored, the motor will restart automatically, e.g. after power failure.

Risk of injury

- Keep out of the device danger zone.# When working on the device, switch off the mains power and ensure that it cannot be switched back on.
- After working on the device, remove any tools used or other objects from the device.

2.5 Safety and protective functions



DANGER

Protective device missing and protective device not functioning

Without a protective device there is a risk of serious injury, for instance if the hands reach or are sucked into the device during operation.

- Operate the device only with a fixed protective device and guard grille.# The fixed protective device must be able to withstand the kinetic energy of a fan blade that becomes detached at maximum speed. There must not be any gaps which it is possible to reach into with the fingers, for example.
- The device is a built-in component. As the operator, you are responsible for ensuring that the device is secured adequately.
- Stop the device immediately if a protective device is found to be missing or ineffective.

2.6 Electromagnetic radiation

Interference from electromagnetic radiation is possible, e.g. in conjunction with open and closed-loop control devices.
 If unacceptable emission intensities occur when the fan is installed, appropriate shielding measures have to be taken by the user.

NOTE

Electrical or electromagnetic interferences after integrating the device in installations on the customer's side.

→ Verify that the entire setup is EMC compliant.

2.7 Mechanical movement



DANGER

Rotating device

Body parts that come into contact with the rotor and impeller can be injured.

- Secure the device against accidental contact.
- Before working on the system/machine, wait until all parts have come to a standstill.

WARNING

Rotating device

Long hair, dangling items of clothing, jewellery and similar items can become entangled and be pulled into the device. Risk of injury.

- Do not wear any loose-fitting or dangling clothing or jewellery while working on rotating parts. # Protect long hair with a cap.

WARNING

Flying parts

If safety devices are missing, this may cause parts to be ejected at high speeds, causing bodily harm, or impair explosion protection.

- Take appropriate safety measures. The safety devices must prevent contact with rotating and electrically live parts.

DANGER

The fan is not supplied with full protective equipment.

- The system in which it is installed must generally be protected against the penetration of objects (IP20 as per EN60529/EN14986). #To ensure ignition protection, rotating parts must be designed throughout the entire production series such that the connection methods employed always reliably stop parts or material working loose. In this context it must also be ensured that loose metallic parts from the surrounding area cannot get into the vicinity of the rotating parts and thus impair ignition protection. #The suitability of the protective device and its attachment must always be assessed in the context of the overall safety concept for the system as a whole.

2.8 Emission

WARNING

Depending on the installation and operating conditions, a sound pressure level greater than 70 dB(A) may arise.

Danger of noise-induced hearing loss

- Take appropriate technical safety measures.
- Protect operating personnel with appropriate safety equipment, e.g. hearing protection.
- Also observe the requirements of local agencies.

2.9 Hot surface



CAUTION

High temperature at the electronics housing
 Risk of burns

- Ensure sufficient contact protection.

2.10 Transport

WARNING

Transportation of fan

Injuries from tipping or slipping.

- Wear safety shoes and cut-resistant safety gloves. #Only transport the fan in its original packaging. #Transport the fan lying flat, in other words with the motor axis vertical.
- Secure the fan(s) so that nothing can slip or tip, e.g. by using a lashing strip.

NOTE

Packaging damaged

ebm-papst Mulfingen will not accept any liability for packaging damages that are reported late.

- Report damages immediately
- Open the product as soon as it arrives.
- Describe the damages in writing
- Sign the description and have the shipper (driver) initial it.

NOTE

Packaging undamaged, content damaged.

In the case of covered transport damage, you have to show that the damage occurred during transport and not afterwards.

- Notify the supplier and ebm-papst of damages within 5 workdays in writing.
- Keep the damaged goods with the packaging until the situation has been clarified.
- Operating damaged devices is prohibited.

2.11 Storage (including stockkeeping of spare parts)

- ⇒ Store the device, partially or fully assembled, in a dry and weatherproof manner in the original packing in a clean environment.
- ⇒ Protect the device from environmental impacts and dirt until the final installation.
- ⇒ Protect the device from unwanted access, e.g. by unauthorised personnel.
- ⇒ We recommend storing the device for a maximum up to one year to guarantee proper operation and longest possible service life.
- ⇒ Even devices explicitly suited for outdoor use are to be stored as described prior to being commissioned.
- ⇒ Observe the correct storage temperature; see chapter 4.5 Transport and storage conditions.



DANGER

Danger of explosion, ingress of dirt and humidity into the motor

The IP type of protection is decreased.

- Store the device in completely assembled condition only (screwed cable gland and terminal box cover are sealed)

2.12 Disposal

When disposing of the device, please comply with all relevant requirements and regulations applicable in your country.

3. PROPER USE

The device is exclusively designed as a built-in device for conveying air according to its technical data.

Note

⇒ The motor satisfies the requirements of category II 2G Ex d e ib IIB T3 Gb. Devices of this category are intended for use in areas in which the occasional occurrence of an explosive atmosphere of air, gases and vapours or mists is to be expected (category 2G). The device-related explosion protection measures of this category must provide the required degree of safety even in the event of frequent system malfunctions or fault statuses normally to be taken into consideration (foreseeable faults). This involves assessment of the individual risks of the system as a whole and implementation of the necessary explosion protection measures.

Any other usage above and beyond this does not conform with the intended purpose and constitutes misuse of the device.

Customer equipment must be capable of withstanding the mechanical and thermal stresses that can arise from this product. This applies for the entire service life of the equipment in which this product is installed.

When used in the intended manner, explosion-proof motors cannot ignite explosive gases or vapours.

The manufacturer who installs ebm-papst devices is responsible for ensuring operation in accordance with the intended use, operational safety, proper installation, and EMC properties when installed.

The fan is designed for 40,000 hours of operation and must then be replaced.

ebm-papst accepts no liability for subsequent modifications to the fan.

Proper use also includes:

- Use the device in power systems with earthed neutral (TN/TT power systems) only.
- Conveying of air at an ambient air pressure of 750 mbar to 1050 mbar.
- Using the device within the permitted ambient temperature range; see chapter 4.2 Nominal data and chapter 4.5 Transport and storage conditions.
- Operating the device with all protective features in place.
- The device may be used in Zones 1 and 2 with explosion subcategories IIA and IIB and temperature classes T1 to T3.
- Only using the device in stationary systems.
- Using the device only in resonance-free speed ranges to avoid spark formation.
- Punctual, complete performance of all maintenance; see chapter 7.3 Maintenance interval.
- Minding the operating instructions.

Improper use

Using the device in the following ways is particularly prohibited and may cause hazards:

- Operating the device with an imbalance, e.g. caused by dirt deposits or icing.
- Conveying air that contains abrasive particles.
- Conveying highly corrosive air, such as salt spray mist. This does not apply to devices designed for use in a salt-laden atmosphere and protected accordingly. The same applies to all other corrosive substances.
- Conveying solids in flow medium.
- Conveying air with a high dust pollution level, e.g. extraction of sawdust, flour dust, etc.
- Conveying air containing iron and rust particles, e.g. use of the device in a welding shop.
- Operation (also when stopped) with external vibrations.
- Operation in unstable flow conditions (vibration).
- Operation with severe contamination (see maintenance instructions).
- Using the device as a safety component or to perform safety-related functions.
- Operation in medical equipment with a life-sustaining or life-support function.
- Operation with vibration transmitted to the fan from external machines or attachments.
- Operation with externally induced mechanical loads that are in excess of the permitted level.
- Opening of the terminal box during operation, see chapter 4.1 Product drawing.
- Painting the fan.
- Standing or walking on the fan or ventilation unit.
- Operation with completely or partially disassembled, manipulated or inadequate protective devices.
- Undoing connections (e.g. screws) during operation.
- Connecting frequency converters upstream.
- Connecting attachments to the rotor housing.
- Flow medium and ambient conditions not in conformity with the Ex marking.
- In addition, all applications not listed as an intended use.



DANGER

Potential dangers in the event of non-compliance include personal injury and property damage due to shaft breakage, fatigue failure, reduced bearing service life or explosions caused by elevated surface temperatures or spark formation.

4. TECHNICAL DATA

4.1 Product drawing

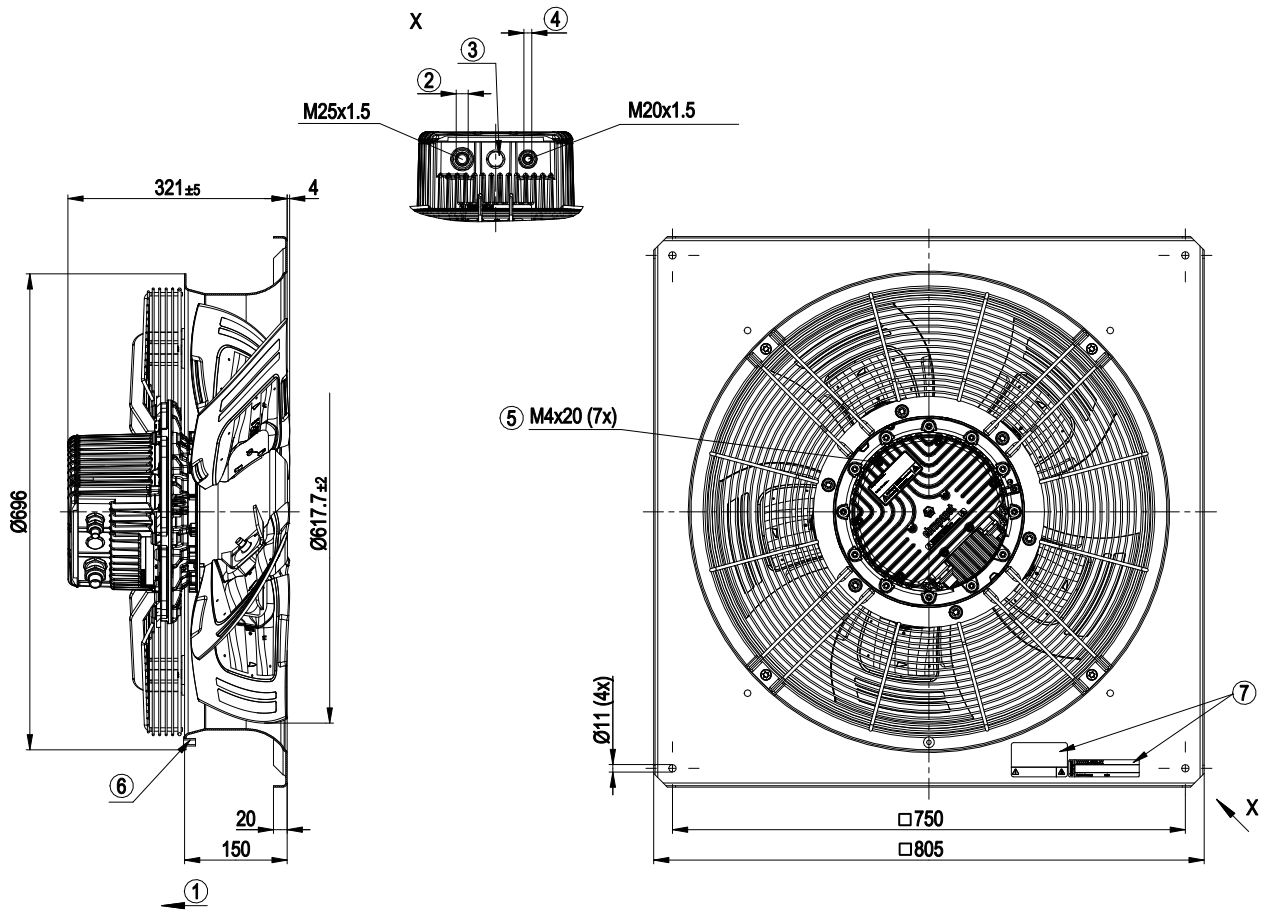

All measures have the unit mm.

1	Direction of air flow "V"
2	Cable diameter min. 10 mm, max. 16 mm, tightening torque 6 ± 0.6 Nm; standard value depending on cable
3	Screw plug M20x1.5
4	Cable diameter min. 10 mm, max. 14 mm, tightening torque 6 ± 0.6 Nm; standard value depending on cable
5	Attachment screws for terminal box cover M4x20, tightening torque 3.5 ± 0.5 Nm
6	Earth connection point M8 (functional earth to dissipate electrostatic charge, no protective earth)
7	Additional type plate and warning sticker in Russian

4.2 Nominal data

Motor	M3G150-IF
Phase	3~
Nominal voltage / V	400
Nominal voltage range / V	380 .. 440
Frequency / Hz	50/60
Type of data definition	ml
State	prelim.
Speed (rpm) / min ⁻¹	1510
Power input / W	3130
Current draw / A	4.8
Max. back pressure / Pa	290
Min. ambient temperature / °C	-40
Max. ambient temperature / °C	60

ml = Max. load · me = Max. efficiency · fa = Running at free air
cs = Customer specs · cu = Customer unit

Subject to alterations

4.3 Technical features

Mass	46.5 kg
Size	630 mm
Surface of rotor	Coated in black
Material of electronics housing	Die-cast aluminium, coated in black
Material of blades	Aluminium sheet insert, sprayed with PP plastic
Material of wall ring	Sheet steel, galvanised and coated in black plastic (RAL 9005)
Material of guard grille	Steel, coated in black plastic (RAL9005)
Number of blades	5
Blade angle	0°
Direction of air flow	"V"
Direction of rotation	Clockwise, seen on rotor
Type of protection	IP 44
Insulation class	"F"
Humidity (F)/ environmental protection class (H)	F4-1
Mounting position	Shaft horizontal with cable exit ±45° or rotor on bottom; rotor on top not permissible
Condensate discharge holes	Rotor-side
Operation mode	S1
Motor bearing	Ball bearing

Technical features	<ul style="list-style-type: none"> - Output 10 VDC, max. 10 mA - Output 20 VDC, max. 50 mA - Output for slave 0-10 V - Operation and alarm display - Input for sensor 0-10 V or 4-20 mA - External 24 V input (programming) - External release input - Alarm relay - Integrated PID controller - Motor current limit - PFC, passive - RS485 MODBUS RTU - Soft start - Control input 0-10 VDC / PWM - Temperature derating - Over-temperature protected electronics / motor - Line undervoltage / phase failure detection
Touch current acc. IEC 60990 (measuring network Fig. 4, TN system)	<= 3.5 mA
Electrical leads	Via terminal box
Motor protection	Reverse polarity and locked-rotor protection
Protection class	I (if protective earth is connected by customer)
Product conforming to standard	EN 61800-5-1; CE
Approval	II 2G; EAC



For cyclic speed loads, note that the rotating parts of the device are designed for maximum one million load cycles. If you have specific questions, contact ebm-papst for support.

4.4 Mounting data

⇒ Secure the mounting screws against accidentally coming loose (e.g. by using self-locking screws).

Strength class for mounting screws	10.9
------------------------------------	------

You can obtain additional mounting data from the product drawing if necessary.

4.5 Transport and storage conditions

⇒ Use the device in accordance with its protection type.

Max. permissible ambient motor temp. (transp./ storage)	+80 °C
Min. permissible ambient motor temp. (transp./storage)	Transport -40 °C / Storage -55 °C °C



4.6 Electromagnetic compatibility

EMC interference immunity	Acc. to EN 61000-6-2 (industrial environment)
EMC interference emission	Acc. to EN 61000-6-4 (industrial environment)



If several devices are switched in parallel on the mains side so that the line current of the arrangement is in the range of 16 - 75 A, then this arrangement conforms to IEC 61000-3-12 provided that the short-circuit power S_{sc} at the connection point of the customer system to the public power system is greater than or equal to 120 times the rated output of the arrangement. It is the responsibility of the installation engineer or operator/owner of the device to ensure, if necessary after consultation with the network operator, that this device is only connected to a connection point with a S_{sc} value that is greater than or equal to 120 times the rated output of the arrangement.

4.7 Ex areas

The device may only be used according to the specifications in the operating instructions; see chapter 3. Proper use.

Zone classification

The zones describe how long an explosive atmosphere may be present. Zones 1 and 2 permit only gases, vapours and mist (no dust) which occur occasionally to seldom in normal operation.

Device categories

The device is approved for Category 2 of Equipment Group II. The categories define the degree of safety.

4.8 The type plate

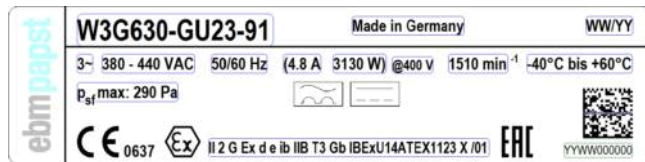

Fig. 1: Specifications on the type plate

Serial number

Designation	Explanation
YY	Year Year, e.g. 11 for 2011, model year
WW	Week Week, calendar week of the model year
Six-digit number, e.g. 000003	Sequential serial number

Ex identification

Ex II 2 G Ex d e ib IIB T3 Gb

Element	Explanation
Ex	Ex marking according to 2014/34/EU
II	Device group (II --> use above ground (not mining))
2	Category 2 --> Zone 1, Category 3 --> Zone 2
G	Ex atmosphere (G --> Gas) (no dust pollution permissible)

Ex d e ib	Ignition protection class (d --> flameproof enclosure, e --> increased safety, ib --> intrinsic safety with protection level)
IIB	Explosion group (for gases of Group IIB)
T3	Temperature class T3, see EN 60079-0
Gb	Equipment protection level

Certificate number IBExU14ATEX1123 X /xx

Element	Explanation
IBExU	Certification body
14	Year of approval
ATEX	In accordance with ATEX product directive 2014/34/EU
1123	Certificate number
X	The "X" symbol after the certificate number indicates special conditions for safe use of the motors, which can be found in these operating instructions.
xx	Supplement to EC type examination certificate for the type concerned

Special conditions for safe use

- The design specifications of the manufacturer must be observed when repairing flame-proof joints. Repair work based on the values of EN 60079-1 is not permissible.
- The cable glands used are only to be employed for fixed installation. Appropriate strain relief must be ensured on installation.
- When replacing cable entries, make sure that these are suitable for a sustained usage temperature of -55°C to +80°C.
- At ambient temperatures below -20°C the connection lines must be suitable for the corresponding usage temperature.
- The heating element should only remain switched on at ambient temperatures up to max. +30°C.



5. CONNECTION AND START-UP

Before commencing work, take the measures specified in your risk assessment, for the protection of employees.

In addition to the generally valid installation requirements for electrical low-voltage equipment, the special requirements for setting up electrical installations in the potentially explosive area must be observed.

5.1 Connecting the mechanical system



DANGER

Insufficient earthing

Electric shock

- The fan must be earthed in the motor terminal box. The earthing points on the wall ring or electronics housing are not substitute for protective earthing in the terminal box (only for dissipation of static electricity).



CAUTION

Cutting and crushing hazard when removing the device from the packaging

Blades can be bent



- Carefully remove the device from its packaging, only touching the wall ring. Make sure to avoid any shock.
- Wear safety shoes and cut-resistant safety gloves.

CAUTION

Heavy load when taking out the device

Bodily harm, e.g. back injuries, are possible.

- Two people should remove the device out of its packaging together.

NOTE

Imbalance

Reduced service life of the device

- Do not hold or transport the device by the blades. Use cloth cable loops, for example, to move the device using a crane.
- After installation, ensure that the impeller can move easily and the blades of the impeller are not deformed or bent and do not scrape anywhere.

NOTE

Mounting peripheral components

- When mounting peripheral components or similar attachments, make sure you use a suitable material (in terms of contact points or contact surfaces) between rotating and stationary parts.
- When mounting such parts, you, the system manufacturer, are responsible for maintaining the safety distance in accordance with EN 14986, for example between the impeller and housing.

NOTE

Shortened service life due to extreme loads

Examples of extreme loads include the effects of moisture, corrosive chemical substances and vibrations. Examples of extreme climatic stressing include extreme heat or cold or high humidity.

- Avoid extreme loads.

- ⇒ Check the device for transport damage. Damaged devices must no longer be installed.
- ⇒ Install the undamaged device according to your application.

- ⇒ The system must not transmit any forces into the device which would cause strain and affect the gaps.
- ⇒ During installation, make sure not to bend or pry the device in order to avoid mechanical tension.
- ⇒ Verify that all rotating parts can move freely. The device must be installed such that the shaft is horizontal or vertical with the rotor facing downwards.
- ⇒ During installation, ensure that the direction of rotation of the device is correct.
- ⇒ Use suitable fastening hardware for the installation.
- ⇒ Remove any objects that are located in the exhaust zone of the fan or near the fan blades.
- ⇒ After installation, ensure that the screws are tightened.
- ⇒ The device must not be subjected to impermissibly high vibration from the system (vibration measurement as per chapter 7.4 Vibration check is required on start-up and as part of regular maintenance).



If multiple ebm-papst fans are installed in one system, please allocate serial numbers to the project and write them down so that in the event of a potential defect, accurate information can be provided about the range of devices affected.

5.1.1 Gap dimension

Radial gap dimension

The gap dimension between the blade and the wall ring is set by ebm-papst and is at least 1% of the impeller diameter (see chapter 4.1 Product drawing). If the connecting screws from the motor to the support bracket/guard grille and/or from the support bracket/guard grille to the wall ring have been loosened, check the gaps and readjust them if necessary.

- ⇒ Prior to start-up of the device and routine checking in accordance with chapter 7.3 Maintenance interval, always check the gap between the wall ring and all fan blades at every position on the wall ring as specified

Axial gap dimension

The clearance between the blade and the customer unit must be at least 1% of the impeller diameter; see chapter 4.1 Product drawing.

- Be sure to maintain this clearance during installation. For aerodynamic reasons, we recommend selecting a greater clearance than the specified minimum clearance.

5.2 Connecting the electrical system



DANGER

Electric voltage on the device

Electric shock

- Always install a protective earth first.
- Check the protective earth.



DANGER

Explosion hazard

- To dissipate electrostatic charges, the fan must be earthed via the earthing point on the wall ring. # Operation of the fan without earthing to dissipate electrostatic charges is not permitted.

**NOTE**

Observe the minimum permissible temperature of -35°C for connection of the cables at the terminals.

The terminals could be damaged.

- Only connect the connection cables at temperatures above -35°C.

**DANGER****Faulty insulation**

Risk of fatal injury from electric shock

- Only use cables complying with the installation specifications with regard to voltage, current, insulation material, load rating etc.# Take care to route the wiring such that it cannot come into contact with any rotating parts.
- Only use cables designed for the current level indicated on the type plate and approved for use in potentially explosive atmospheres.

CAUTION**Electrical voltage**

The fan is a built-in component and features no electrically isolating switch.

- Only connect the fan to circuits that can be switched off with an all-pole separating switch.
- When working on the fan, you must switch off the installation/machine in which the fan is installed and secure it from being switched on again.

NOTE**Interferences and failures are possible**

Maintain a distance to the power supply line when routing the control lines of the device.

- Ensure a sufficiently large clearance.
Recommendation: clearance > 10 cm (separate cable routing)

NOTE**Water penetration into leads or wires**

Water enters at the cable end on the customers side and can damage the device.

- Make sure that the cable end is connected in a dry environment.

5.2.1 Prerequisites

- Check whether the data on the type plate agree with the connection data.
- Before connecting the device, ensure that the supply voltage matches the operating voltage of the device.
- Only use cables designed for the current level indicated on the type plate; see chapter 5.3.3 Connecting cables with terminals. For determining the cross-section, observe the basic principles according to EN 61800-5-1. The protective earth must have a cross-section equal to or greater than the phase conductor cross-section. We recommend the use of 105°C cables.
- Only use cables approved for the corresponding ambient temperature.
- Do not subject the connection lines to impermissible strain.
- Establish a safe protective earth connection.
- Ensure compliance with the protection rating. The seals in the terminal box from ebm-papst have been inspected for their suitability.

The motor must be connected in accordance with EN 60079-14.

Earth wire contact resistance to EN 61800-5-1

Compliance with the impedance specifications according to EN 61800-5-1 for the protective earth connection circuit must be verified in the application. Depending on the installation situation, it may be necessary to connect an additional protective earth conductor to the extra protective earth terminal on the device. The protective earth terminal with an earth conductor symbol and a hole is located on the housing.

5.2.2 Power supply connection, fuse protection

Assignment of conductor cross-sections and the fuse protection required for them (overload protection only, no device protection).

Nominal voltage	Safety fuse		Automatic circuit breaker	Wire cross-section	Wire cross-section
	VDE	UL	VDE	mm ²	*AWG
3/PE AC 380 - 440 VAC	16 A	15 A	C16A	1.5	16
3/PE AC 380 - 440 VAC	20 A	20 A	C20A	2.5	14
3/PE AC 380 - 440 VAC	25 A	25 A	C25A	4.0	12

* AWG = American Wire Gauge

5.2.3 Idle current

Because of the EMC filter integrated for compliance with EMC limits (interference emission and interference immunity), idle currents in the mains cable can be measured even when the motor is at a standstill and the mains voltage is switched on.

- The values lie in a range of typical < 250 mA.
- The effective power in this operating state (readiness for operation) is simultaneously at typical < 5 W.

5.2.4 Residual current operated device

Only universal (type B or B+) RCD protective devices are permitted. Like frequency inverters, RCD protective devices cannot provide personal safety while operating the device. When switching on the power supply of the device, pulsed charge currents from the capacitors in the integrated EMC filter can lead to the RCD protective devices triggering without delay. We recommend residual current devices with a trigger threshold of 300 mA and delayed triggering (super-resistant, characteristic K).

5.2.5 Leakage current

For asymmetrical power systems or if a phase fails, the leakage current can increase to a multiple of the nominal value.

5.3 Connection in terminal box

5.3.1 Delivery condition of terminal box

The terminal box of the fan supplied by ebm-papst is equipped with the following screwed cable glands.

Line	Outer diameter of wire	Terminal area of the terminal strip	Manufacturer order number (Hugro)
Mains supply connection M25 x 1.5	Ø 10 mm to Ø 16 mm	1.5 mm ² to 4 mm ²	154.2516.37
Control line M20 x 1.5	Ø 10 mm to Ø 14 mm	0.5 mm ² to 1.5 mm ²	154.2014.37
Plug screw M20 x 1.5	-	-	548.20.14

5.3.2 Preparing connection lines for the connection

Use can be made of cables with or without shielding. The following two illustrations show the lengths to which the cables are to be cut. For correct wiring, refer to chapter 5.3.3 Connecting cables with terminals. Only strip the cable as far as necessary, ensuring that the cable gland is sealed and there is no strain on the connections. Tightening torques, see chapter 4.1 Product drawing.

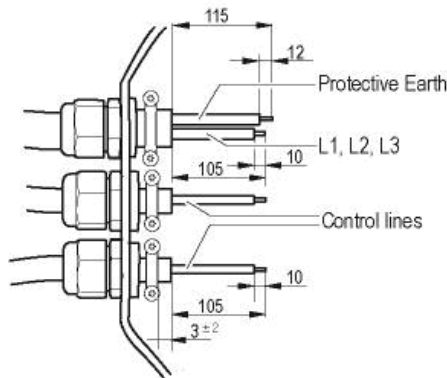

Fig. 2: Recommended stripping lengths in mm (inside terminal box) for non-shielded cables. By way of example, all cable glands are used in this illustration. The illustration may differ from the actual device design.

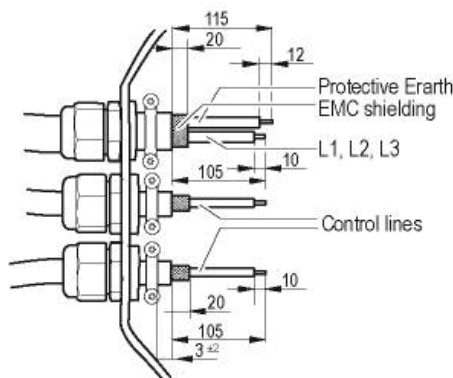

Fig. 3: Recommended stripping lengths in mm (inside terminal box) for shielded cables. By way of example, all cable glands are used in this illustration.

5.3.3 Connecting cables with terminals

- ⇒ Open the terminal box.
- ⇒ To do so, unscrew the seven attachment screws; for tightening torque, see chapter 4.1 Product drawing.



Take care when opening the terminal box cover. Do not damage the terminal box seal by using tools to open it. A protective earth is installed on the terminal box cover. This connection must not be broken.

If the original screws of the terminal box cover have been lost, use metric and corrosion-resistant screws; for size see chapter 4.1 Product drawing.

- ⇒ Remove the cap from the screwed cable gland.



Only Ex e-approved plug screws may be used; see Other types of closure, e.g. using cables, are not permitted.

- ⇒ Use one sheathed cable for each screwed cable gland.
- ⇒ Use copper wires only.
- ⇒ Check that the wires are clean.
- ⇒ Insert the line(s) (not included in the standard scope of delivery) into the terminal box.



The mains line (PE and L1 - L3) must always be routed separately and must not be routed together with the control line. Pay attention to the cross-sections of the strands and cable glands.



If using shielded cables, the shielding has to be folded back over the wire sheath and fixed under the strain relief clamps; see the illustration "Strain relief for shielded cables".

- ⇒ First connect the "PE" (protective earth) connection.
- ⇒ Connect the lines to the corresponding terminals.

Use a screwdriver to do so.

During the connection work, ensure that no cables splice off.

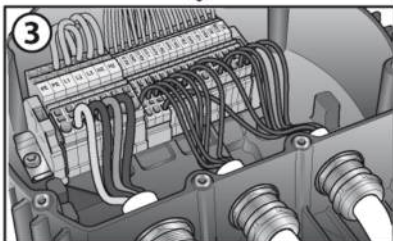
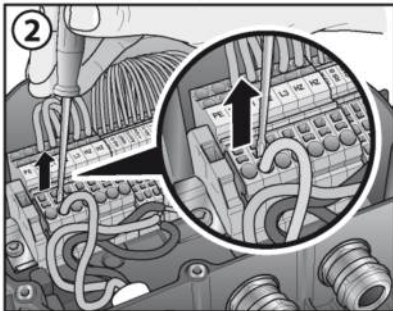
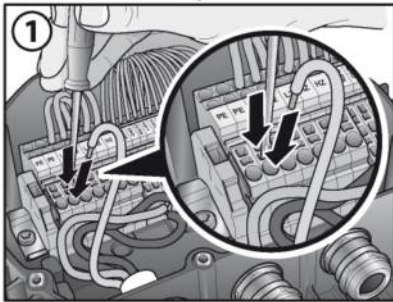
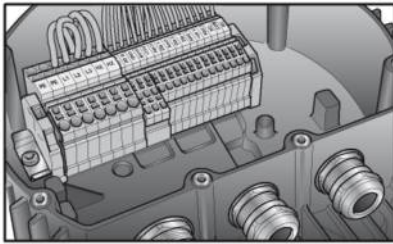

Fig. 4: Connecting wires to terminals (example)

There must be no mechanical load applied between the terminal and the cable gland. The cable must be relieved of strain.

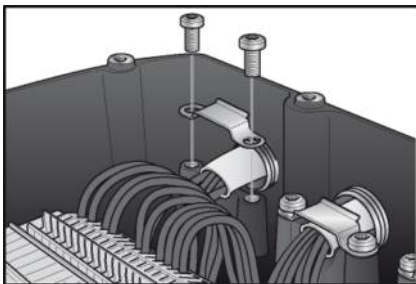

Fig. 5: Secure the brackets (included in terminal box) for strain relief of the wires

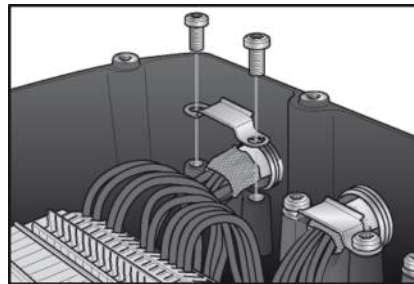

Fig. 6: Strain relief for shielded wires



The strain relief acts on the cable sheath, which eliminates load on the single strands.



DANGER

Risk of explosion due to poorly sealed terminal box.

The terminal box cover, its seal and the contact surface on the housing must not be soiled or damaged.

→ Clean the contact surfaces if soiled, note the section on cleaning.# If damaged, send the device to ebm-papst for repair/replacement.



The terminal box is only properly sealed if the terminal box screw connections and cable glands have been tightened to the specified torque.

5.3.3.1 Exchange of screwed cable glands and plug screws

If you would like to replace screwed cable glands or plug screws, for example because they have been lost or become worn out, the following characteristics must be met.



CAUTION

Required properties for cable glands and screw plugs:- Ex e approval

- Usage temperature -40°C to 85°C
- Connection thread M20 x 1.5 mm or M25 x 1.5 mm
- Sizing corresponding to cable diameter
- Material: Nickel-plated brass or stainless steel

5.3.4 Cable routing

No water may penetrate along the cable in the direction of the cable gland. To relieve strain on the cables, we recommend fastening the connection lines at intervals of 10 cm.

Fans installed lying flat

Make sure the cables are routed in a U-shaped loop.

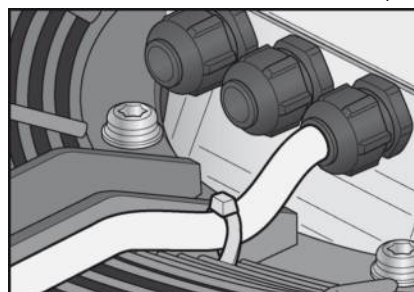

Fig. 7: Fan installed lying flat, cable routed as a water trap.

Fans installed in upright position

When routing the cable, ensure that the screwed cable glands are arranged at the bottom. The cables must always be routed downwards.

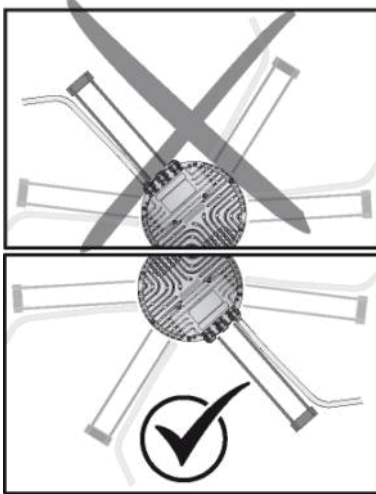

Fig. 8: Cable routing for fans installed upright.

5.4 Factory settings

Factory settings with which the device is pre-set by ebm-papst.

Control mode parameter set 1	PWM controlling
Control mode parameter set 2	PWM controlling
Fan / device address	01
Max. PWM / %	100
Min. PWM / %	5
Save set value to EEPROM	Yes
Set value control	Analogue (linear)
Control function parameter set 1	Positive (heating)
Control function parameter set 2	Positive (heating)

5.5 Connection screen

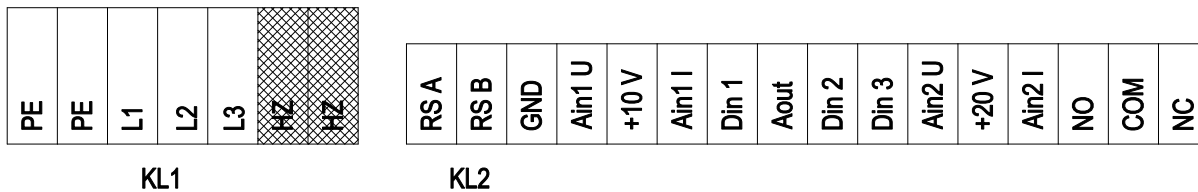

Shading => terminals not assigned

No.	Conn.	Designation	Function / assignment
1		PE	Earth connection, PE connection
1		L1	Mains supply connection, supply voltage 3-phase, 380- 440 VAC, 50/60 Hz
1		L2	Mains supply connection, supply voltage 3-phase, 380- 440 VAC, 50/60 Hz
1		L3	Mains supply connection, supply voltage 3-phase, 380- 440 VAC, 50/60 Hz
1		HZ	Not used (optional: internal heating element)
2		RSA	Bus connection RS485; RSA; MODBUS RTU; double terminal (SELV)
2		RSB	Bus connection RS485; RSB; MODBUS RTU; double terminal (SELV)
2		GND	Signal ground for control interface (SELV)
2		Ain1 U	Analogue input 1, set value: 0-10 V, Ri = 100 kΩ, parametrisable curve, only for use as alternative to input Ain1; SELV
2		+10 V	Fixed voltage output 10 VDC, +10 V +/-3%, max. 10 mA, short-circuit-proof, power supply for ext. devices (e.g. potentiometer); SELV
2		Ain1 I	Analogue input 1, set value: 4-20 mA; Ri = 100 Ω, parametrisable curve, only for use as alternative to input Ain1 U; SELV
2		Din 1	Digital input 1: Enabling of electronics, Enabling: Pin open or applied voltage 5-50 VDC Disabling: Bridge to GND or applied voltage <1 VDC Reset function: Triggers software reset after a level change to <1 VDC; SELV
2		Aout	Analogue output 0-10 VDC, max. 5 mA, output of the current motor level control coefficient / motor speed parametrisable curve; SELV
2		Din 2	Digital input 2: Parameter set 1/2 switching, depending on EEPROM setting, the valid/used parameter set can be selected via the bus or via the digital input DIN2. Parameter set 1: Pin open or applied voltage 5-50 VDC Parameter set 2: bridge to GND or applied voltage <1 VDC; SELV
2		Din 3	Digital input 3: Controller function of integrated controller; depending on EEPROM setting, normal / inverse can be selected for the controller function of the integrated controller via the bus or the digital input Normal: Pin open or applied voltage 5-50 VDC Inverse: bridge to GND or applied voltage <1 VDC; SELV
2		Ain2 U	Analogue input 2, actual value: 0-10 V, Ri = 100 kΩ, parametrisable curve, only usable as alternative to input Ain2; SELV
2		+20 V	Fixed voltage output 20 VDC, +20 V +/-10%, max. 50 mA, short-circuit-proof, power supply for ext. devices (e.g. sensors); SELV Alternatively: +24 V DC input for parametrisation via MODBUS without mains power
2		Ain2 I	Analogue input 2, actual value: 4-20 mA, Ri = 100 Ω, parametrisable curve, only for use as alternative to input Ain2 U; SELV
2		NO	Status relay; floating status contact; make for failure
2		COM	Status relay, floating status contact, common connection, contact rating 250 VAC / max. 2 A (AC1) / min. 10 mA
2		NC	Status relay; floating status contact; break for failure



5.6 Checking the connections

- ⇒ Make sure that the power is off (all phases).
- ⇒ Secure it from being switched on again.
- ⇒ Check the correct fit of the connection lines.
- ⇒ Route the connecting cables in the terminal box so that the terminal box cover closes without resistance. The strands must not be trapped between the terminal box cover and housing.
- ⇒ Screw the terminal box cover back on again. Terminal box tightening torque, see chapter 4.1 Product drawing.
- ⇒ Use all plug screws (the entire number). In doing so, insert the screws manually to avoid damage to the thread.
- ⇒ Make sure that the terminal box is correctly closed and sealed and that all screws and screwed cable glands are properly tightened.
- ⇒ The supply lines to the add-on unit, e.g. exchanger, must conform to the IP protection rating (see type plate). Do not route the cables over any sharp-edged objects.

5.7 Switch on device

The device may only be switched on if it has been installed properly and in accordance with its intended use, including the required safety mechanisms and professional electrical connection. This also applies for devices which have already been equipped with plugs and terminals or similar connectors by the customer.

- ⇒ Inspect the device for visible external damage and the proper function of the protective features before switching it on.
- ⇒ Check the air flow paths of the fan for foreign objects and remove any that are found.
- ⇒ Apply the nominal voltage to the voltage supply.
- ⇒ Start the device by changing the input signal.

5.8 Switching off the device

5.8.1 Switch off device during operation

- ⇒ Switch off the device via the control input.
- ⇒ Do not switch the motor (e.g. in cyclic operation) on and off via power supply.

5.8.2 Switching off the device for maintenance work

- ⇒ Switch off the device via the control input.
- ⇒ Disconnect the device from the supply voltage.

If the device (terminal box cover) has to be opened and disconnected from the supply line, observe the following:



DANGER

Electrical load (>50 µC, 60 µJ) between mains wire and protective earth connection after switching off the supply when switching multiple devices in parallel.

Electric shock, risk of injury

→ **Important! The terminal box cover must not be opened within a potentially explosive area before the wires (L1, L2, L3) and PE are short-circuited outside the potentially explosive area (e.g. on the main switch).**

- ⇒ Disconnect the connection line on the device.
- ⇒ When disconnecting, be sure to disconnect the earth wire connection last.

6. INTEGRATED PROTECTIVE FUNCTIONS

The integrated protective functions cause the motor to switch off automatically in case of faults described in the table.

Malfunctions	Description / Function of safety feature
Rotor position detection error	No automatic restart occurs.
Locked rotor	⇒ After the blockage is removed, the motor restarts automatically.
Line under-voltage (mains input voltage outside of permitted nominal voltage)	⇒ If the mains supply voltage returns to permitted values, the motor restarts automatically.
Phase failure	A phase of the supply voltage fails for at least 5 s. ⇒ If all phases are correctly supplied again, the motor automatically restarts after 10 - 40 s.
Overtemperature of motor, electronics interior and power electronics	No automatic restart. Reset the instrument manually.

7. MAINTENANCE, MALFUNCTIONS, POSSIBLE CAUSES AND REMEDIES

Do not perform any repairs on your device. Send the device to ebmpapst for repair or replacement.

During maintenance work on the fan, e.g. when cleaning the fan blades, the fan must be stationary and the electrical circuit of the ventilation unit must be interrupted and secured from being switched on again.

- ⇒ Wait until the device stops.



WARNING

Live terminals and connections even with device switched off

Electric shock

- When shutting off the device, note chapter 5.8 Switching off the device.# Wait five minutes after disconnecting the voltage at all poles before opening the device.

CAUTION

If control voltage is applied or a speed setpoint is stored, the motor will restart automatically, e.g. after power failure.

Risk of injury

- When working on the device, switch off the mains power and ensure that it cannot be switched back on.# Wait until the device stops.
- Keep out of the device hazard zone.
- After working on the device, remove any tools used or other objects from the fan air paths.



If the device remains out of use for over four months, we recommend switching the device on for at least three hours at full speed to allow any condensate to evaporate and to move the bearings.

- ⇒ Carry out inspections and cleanings according to the Ex protection class so that no dirt deposits form.

Malfunction/error	Possible cause	Possible remedy
-------------------	----------------	-----------------





Impeller running roughly	Imbalance in rotating parts	Clean the device; replace if imbalance is still found after cleaning. Make sure no weight clips are moved, damaged or removed during cleaning.
Motor does not turn	Mechanical blockage	Switch off, de-energise, and remove mechanical blockage.
	Mains supply voltage faulty	Check mains power, restore power supply. Attention! The error message resets automatically. The device starts up again automatically without advance warning.
	Faulty connection	De-energise, correct connection, see connection diagram.
	Motor winding broken	Replace device
	Insufficient cooling	Improve cooling. Let the device cool down. To reset the error message, switch off the mains supply voltage for a min. of 25 s and switch it on again. Alternatively, reset the error message by applying a control signal of <0.5 V to DIN1 or by short circuiting Din1 to GND.
	Ambient temperature too high	Reduce the ambient temperature. Let the device cool down. To reset the error message, switch off the mains supply voltage for a min. of 25 s and switch it on again. Alternatively, reset the error message by applying a control signal of <0.5 V to DIN1 or by short circuiting Din1 to GND.

	Impermissible operating point (e.g. excessive load, back pressure too high)	Correct the operating point. Let the device cool down. To reset the error message, switch off the mains supply voltage for a min. of 25 s and switch it on again. Alternatively, reset the error message by applying a control signal of <0.5 V to DIN1 or by short circuiting Din1 to GND.
Mounting screws of terminal box broken during closing		Replace device



If you have any other problems, contact ebm-papst.

7.1 Cleaning

NOTE

Damage to the device during cleaning

Malfunction possible

- Do not clean the device using a water jet or high-pressure cleaner. # Do not use any acid, alkali or solvent-based cleaning agents. # Do not use any pointed or sharp-edged objects for cleaning



Regular cleaning of the device prevents unbalance caused by deposits for example.

7.2 Safety test

NOTE

High-voltage test

The integrated EMC filter contains Y capacitors. Therefore, the trigger current is exceeded when AC testing voltage is applied.

- Test the device with DC voltage when you carry out the high-voltage test required by law. The voltage to be used corresponds to the peak value of the AC voltage required by the standard.

7.3 Maintenance interval

What has to be tested?	How to test?	Frequency	Which measure?
Corrosion	Visual inspection	At least every 3 months	When there is strong corrosion that impairs the EX protection, e.g. in gap surfaces, replace the device.





Check the protective casing against accidental contact for damage and to ensure that it is intact	Visual inspection	At least every 6 months	Repair or replacement of the device
Check the device for damage to blades and housing	Visual inspection	At least every 6 months	Replacement of the device
Mounting the connection lines	Visual inspection	At least every 6 months	Fasten
Check the insulation of the wires for damage	Visual inspection	At least every 6 months	Replace wires
Tightness of screwed cable gland	Visual inspection	At least every 6 months	Retighten, replace if damaged
Drain holes to prevent clogging, as necessary	Visual inspection	At least every 6 months	Open bore holes
Weld seams for crack formation	Visual inspection	At least every 6 months	Replace device
Cable routing (fastening)	Visual inspection	At least every 6 months	Fasten cables
Cleaning and preventive maintenance	Visual inspection	At least every 3 months	Remove dirt, clean the device
Check the ball bearings to ensure they are quiet, can move easily and are free of play	Acoustic and/or manual check by turning the rotor whilst switched off, vibration test	At least every 3 months	Replace the device in the event of noise, stiffness or bearing play. Have the motor bearings replaced by ebm-papst.
Vibration test	See Vibration test section	At least every 6 months	Cleaning, repair or replacement of device
Check gap dimensions	See Gap dimensions section	At least every 3 months	Replacement of device

7.4 Vibration check

Regular checks must be made to ensure that the fan is not operated with impermissibly high vibration values. On the basis of ISO 14694, the maximum permissible vibration velocities are specified as follows:

Fan connected to system with isolation from vibration	Fan connected to system without isolation from vibration
Vibration velocity	Vibration velocity
Max. 6.3 mm/s	Max. 4.5 mm/s

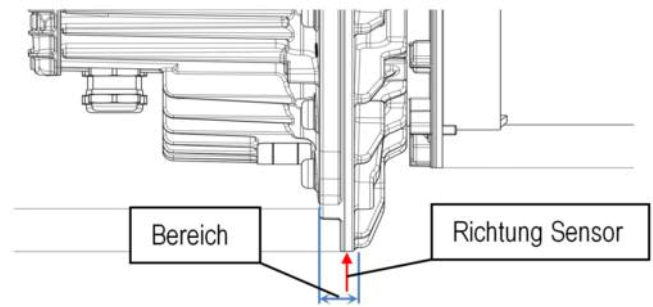

Fig. 9: The vibration velocities are measured in radial direction at the stator bush.

The motor bearings are provided with lifetime lubrication at the factory. Experience has shown that under normal operating conditions the grease therefore only has to be renewed after several years. The motor must be deactivated in the event of bearing noise. To remedy this, the motor has to be exchanged or the defective bearings replaced by the ebm-papst Service department.

A record is to be kept of the routine inspections performed.

